

2023

FIVICS PRODUCT CATALOGUE

We are
**TEAM
FIVICS**

FIVICS

**LEAD TO
VICTORY**



FIVICS CUP

The inaugural FIVICS INDOOR CUP was held on December 24-25, 2022 in Nagoya, Aichi Prefecture, Japan with great success! We will hold the Fivics Indoor Cup every year to improve the development of the next generation of archers and coaches, as well as hosting a public audience to learn and participate in our sport. Fivics will continue to improve the quality of this competition and bring even more participants next year. We look forward to seeing you at the next Fivics competition!

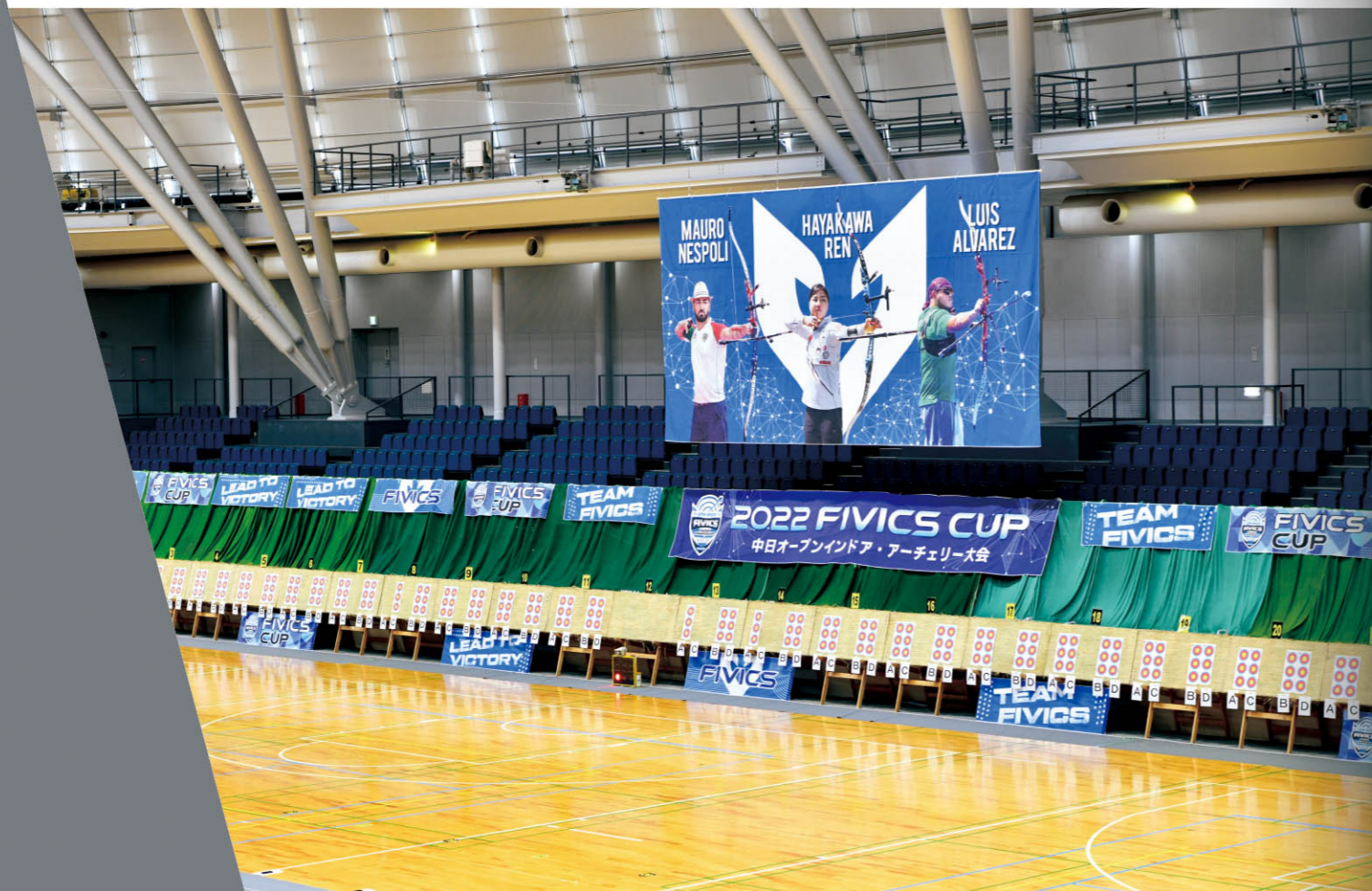

We are
**TEAM
FIVICS**

FIVICS BOWS

SKADI BOW	16
ARGON-X BOW	20
TITAN-NX BOW	22
VELLATOR-V3 BOW	24
VELLATOR-V2 BOW	26
SIRASONI BOW	27

FIVICS ARROWS

FIVE-X ARROW	30
TENPRO ARROW	31
GOLDRO ARROW	32
ZEILO ARROW	33
TUNGSTEN POINT	36
ARROW ACCESSORIES	38

FIVICS BOW ACCESSORIES

SKADI-BX STABILIZER	40
FORNIX 14 STABILIZER	42
VELLATOR STABILIZER	44
STABILIZER ACCESSORIES	45
AIREX CUSHION PLUNGER	46
SM540 CUSHION PLUNGER	48
FV-300S SIGHT	49
CLICKER · REST	50
UPSTABILIZER	51
ETC	52

FIVICS FINGER TABS

TENFIX FINGER TAB	54
SAKER SERIES	56
BRASS SAKER SERIES	57
SAKER PLUS FINGER TAB	58
POLITE SERIES	58
FALCON FINGER TAB	59
FINGER SPACER	59

FIVICS PROTECTORS

	60
--	----

CONTENT

FIVICS SHOOTING GEAR

UNICO QUIVER SERIES	62
ACCENDO QUIVER SERIES	63
AEGIS HARD BOW CASE SERIES	64
THUNDER-M COMPOUND CASE	66
TENTRON-M BACKPACK	67
SHOOTING GEARS / ETC	68

OTHER

	70
--	----

FIVICS TARGET FACES

	73
--	----

KROSSEN

XENIA BOW	78
XENIA STABILIZER	79
SIGHTS	80
BOW ACCESSORIES	81
FINGER TABS	82
PROTECTORS / ETC	83
HYPER QUIVERS SERIES	84
HYPER BACKPACK	85

**LEAD TO
VICTORY**

FIVICS' BRAND NEW PRODUCT LINE

SKADI SERIES

Mythology coming to life!

SKADI-TX RISER

Tungsten weights are inserted into the riser to add a subtle balance shift, optimizing the distribution. The SKADI-TX is designed with soft curves which minimizes unwanted movement of the bow at release. The SKADI-TX debuts the new "VACP" plate which can be adjusted forwards and backwards, allowing for fine tuning to optimize arrow flight!

SKADI LIMBS

SUPER GRAPHITE has improved stability and accuracy compared to other carbon fiber limbs. To improve the stability and accuracy of the SKADI limb, a new material, SUPER GRAPHITE, was integrated. Super graphite maintains the high elasticity of carbon with reduced torsion to decrease excess vibration and offers a satisfying shooting sensation.

SKADI-BX STABILIZER

Super graphite is a carbon prepreg material that has evolved further from graphene, a next-generation new material, featuring a greatly improved vibration absorption rate compared to previous stabilizer technology.

SKADI-TX



SKADI



SKADI-BX

TECHNOLOGY OF FIVICS RISERS LIMBS



Additional Fine Tuning Aid

VACP SYSTEM

Variable Arrow Cushion Point / Position

The VACP plate can be adjusted forwards and backwards, which allows for the fine tuning to optimize arrow flight.

Front Position
(To stiffen a weak arrow)



Normal Position



Back Position
(To weaken a stiff arrow)



1 in 1000 mm precision

FULL CNC

ALL FIVICS LINE RISERS FEATURE FULL CNC

Full CNC is made by cutting a solid block aluminum with a CNC machine tool, so production is limited and the cost of the process is high.

Some manufacturers do not release Full CNC products due to profitability.

However, as Full CNC has a precision of 1/1000mm, the product is vastly superior to that of casting and forging. Each product is perfectly centered at the vertical and there are no deviations between products.

Method	Casting	CNC After Forging	Full CNC
Precision	Low	Medium	Premium
Durability	Low	High	High
Deviation Between Products	High	Medium	None
Vertical Center Deviation	High	Medium	None
Production Unit Price	Low	Medium	Very High



TX BALANCE SYSTEM

Tungsten weights are inserted into the riser to add a subtle balance shift, optimizing the weight distribution. The SKADI TX is designed with soft curves which minimizes unwanted movement of the bow at release.

TX BALANCE SYSTEM

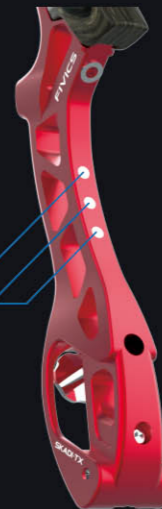



THE LIMB ALIGNMENT ADJUSTMENT SYSTEM IN 0.05mm



Normally, limb alignment adjustment with the washer system is able to adjust in 0.1mm increments. FVICS' ultra-precise limb alignment system can adjust 0.05mm to 0.15mm, offering double the amount of precision.



EASY & STABLE CENTER ADJUSTMENT

Adjusting the limb alignment without removing the limbs

Perform bow center adjustment without disassembling the riser and limb alignment system. The limb alignment system allows a strong fixing force with only one locking bolt.

Limb Alignment System

- Loosen the locking bolt
- String is left of center** : Loosen the adjustment bolt and the right set screw. Tighten the left set screw to move the limb to the right.
- String is right of center** : Loosen the adjustment bolt and left set screw. Tighten the right set screw to move the limb to the left.
- Tighten the locking bolt

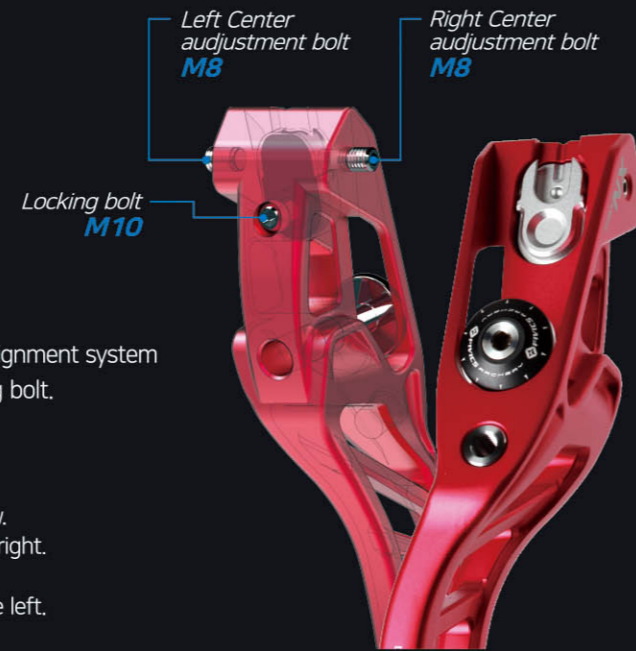

STABLE & STEADY GEOMETRY

The FVICS risers are designed with a stable low center of gravity, creating significantly less vibration and shake than a normal riser during shooting. This also has the added benefit of the bow falling faster after the shot, which increases the arrow speed and reduces accidental influence that may be caused by minute hand movement.

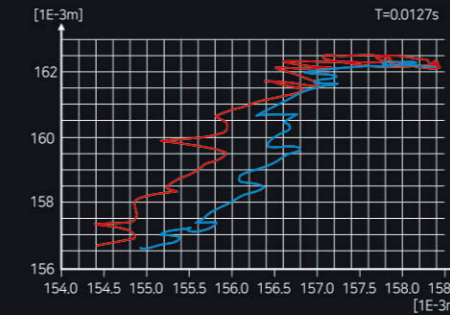

7075 RISER VS 6061 RISER

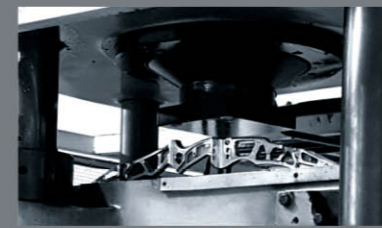

The Argon and Titan Risers are designed with 6061 aluminum to allow for the best vibration absorption possible. Using a hydraulic press machine, we have scientifically proven that our 6061 aluminum risers can tolerate higher pressure than risers made from more rigid materials such as 7075 aluminum.

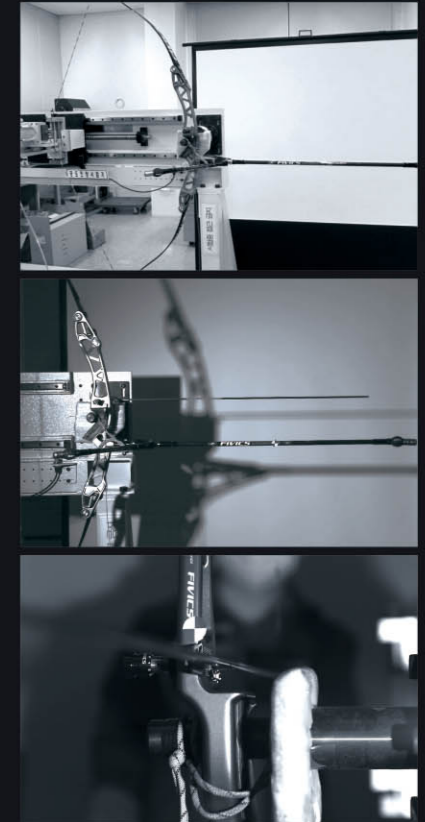
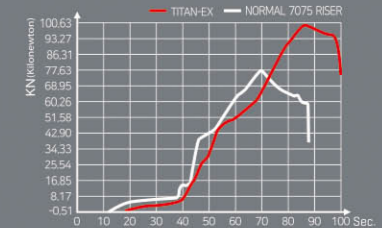



3 important points in grip system

TIGHT AND SECURE GRIP

FVICS' TSG (Tight and Secure Grip) is designed to maximize the contact between the archer's bow hand and the grip. This grip was produced in an optimal shape specializing in close contact by analyzing the close contact between the hand and the grip in three dimensions as well as analyzing the direction of the force received by the bow hand during anchoring.

The FVICS TSG is combined with FVICS' STABLE & STEADY GEOMETRY Riser to exert a synergistic effect which promotes the bow to move to the target at a faster speed and allows a stable control of the arrow even at high speeds.

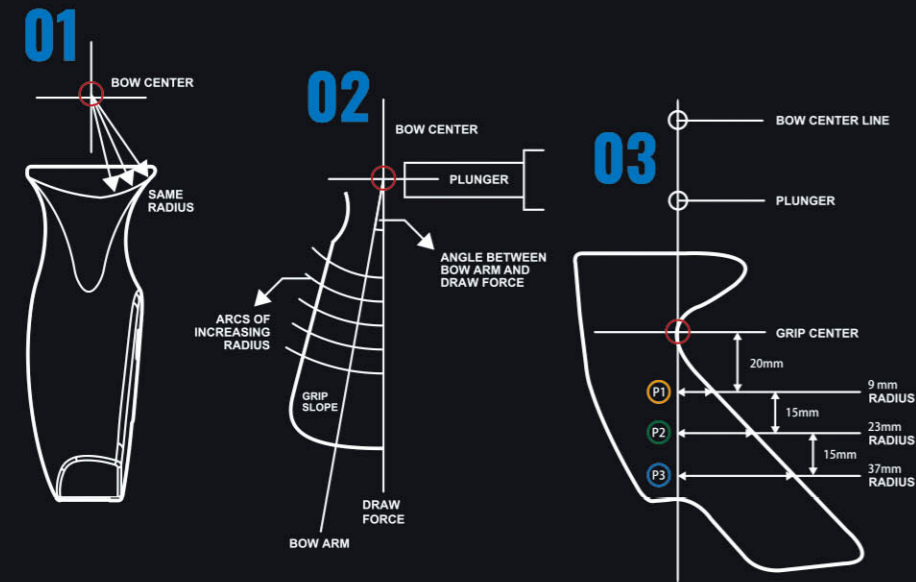

All FVICS line Limbs

CWP CARBON PREPREG MATERIAL

We have developed a unique Carbon "Prepreg material" specifically designed for the highest performance in archery.

This material allows efficient pull kinetics and quick restoration.

- The most important part of an archery limb is the carbon's raw material.
- In the process of producing good carbon materials, prepreg technology of epoxy and carbon fiber is proportional to the tension and torsion of the limbs.

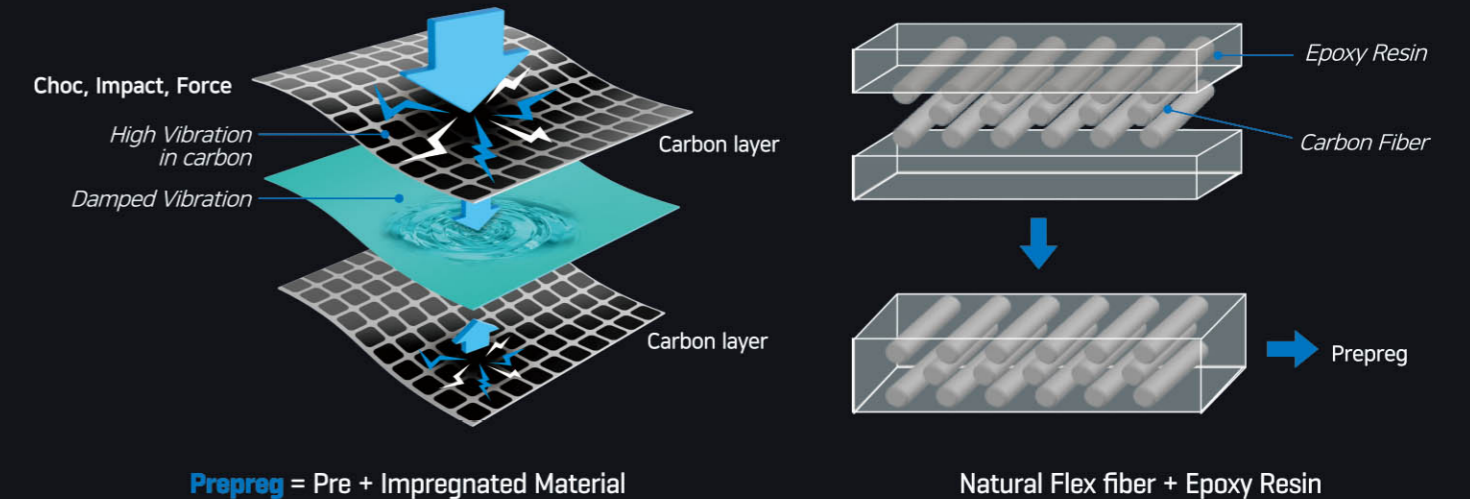

Prepreg = Pre + Impregnated Material

Natural Flex fiber + Epoxy Resin





New type of Limbs Argon X - Surprising effect of

45° CARBON TECHNOLOGY

Glass fiber is used to protect carbon within the limb, but this combination reduces arrow speed due to the heavy mass weight. The 45 degree carbon system increases shooting stability, protecting the carbon as well as reinforcing anti-twisting.

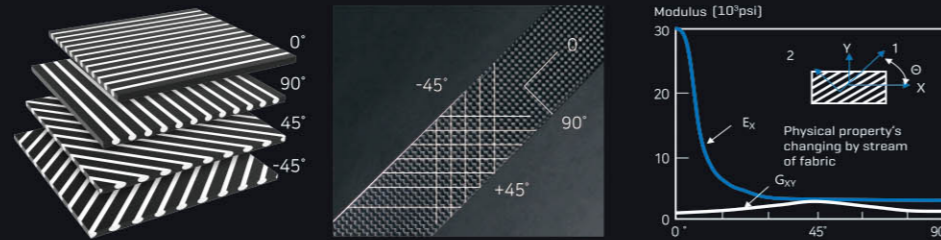

New type of Limbs Argon X - Surprising effect of

POWER ZONE BALANCE

The location and angle of the Power Zone has been improved (area that creates the most acceleration)

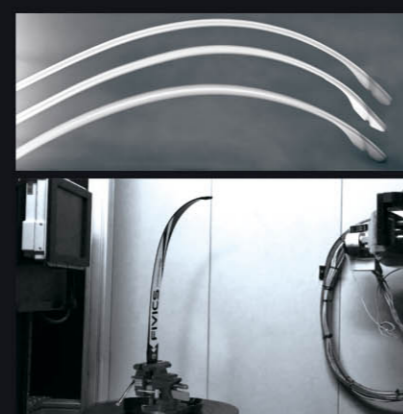
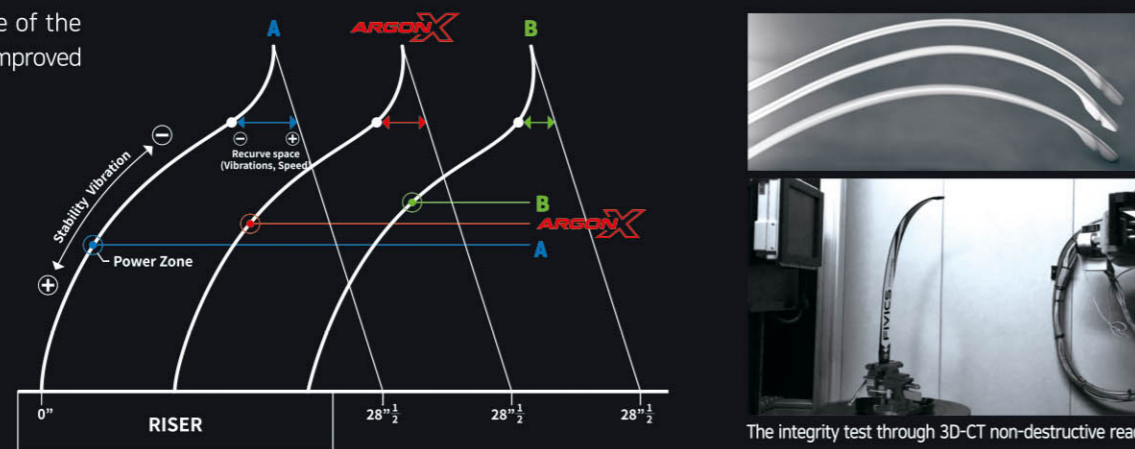

The integrity test through 3D-CT non-destructive read



AR TECH - INNOVATIVE LIMB CNC PROCESSING

AR technology utilizes CNC processing to increase the consistency and uniformity of limbs while maintaining similar successful performances made with previous materials. Additionally, this production eliminates all air in the adhesion process, minimizing the change of limb fracture and torsion. The new 330-carbon improves the elasticity of the limb and optimizes speed and stability.



Increased limb strength while maintaining the same stability and uniform elasticity.

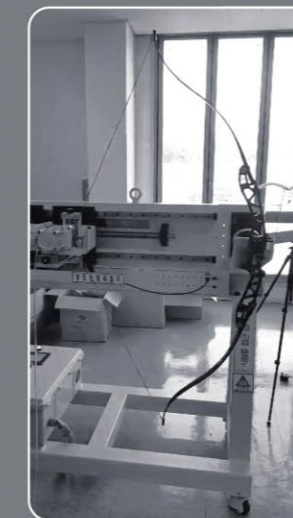

28" FULL DRAW DRY FIRE TEST

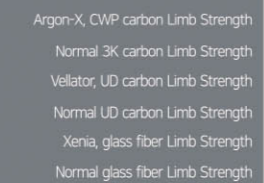
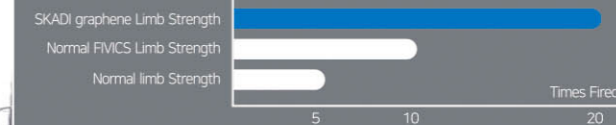

26" PARTIAL DRY FIRE TEST

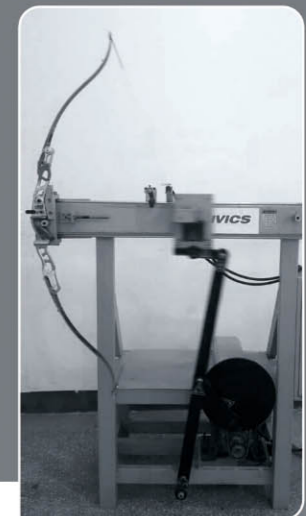

SKADI-TX



EXCEPTIONAL RISER WITH SOPHISTICATED SHOOTING BALANCE CUSTOMIZATION

SKADI-TX 25" RISER HS0825 / NEW

VACP system / TX balance system / Superfine full CNC milling / Adjustable limb alignment with an M8 and M10 wrench without removing limbs / Stable & steady geometry / Tight & secure wooden grip / Deep color from anodizing

PROCESSING CNC **WEIGHT** 1,282g **MATERIAL** AL 6061, Tungsten
TYPE RH / LH **GRIP** TSG Wood Grip **COLOR** Anodized, Painted **LENGTHS** 25"

Stabilizer Mount Thread 5/16"-24 **Upstabilizer Mount Thread** 5/16"-24
Cushion Plunger Mount Thread 5/16"-24 **Clicker Mount Thread** 6/32"

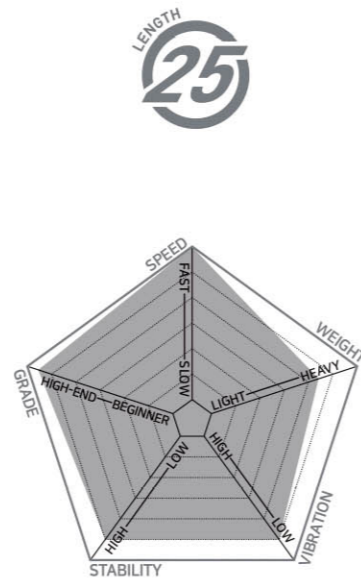

- VACP SYSTEM
- 74W Tungsten TX BALANCE
- FULL CNC
- ESA
- SS GEOMETRY
- TSG



TECHNOLOGY OF FIVICS RISERS

TECHNOLOGY OF SKADI RISER

VACP SYSTEM - Additional Fine Tuning Aid Variable Arrow Cushion Point / Position

The VACP plate can be adjusted forwards and backwards, which allows for the fine tuning to optimize arrow flight.

Front Position
(To stiffen a weak arrow)



Normal Position



Back Position
(To weaken a stiff arrow)



TX BALANCE SYSTEM

Tungsten weights are inserted into the riser to add a subtle balance shift, optimizing the weight distribution. The SKADI TX is designed with soft curves which minimizes unwanted movement of the bow at release.

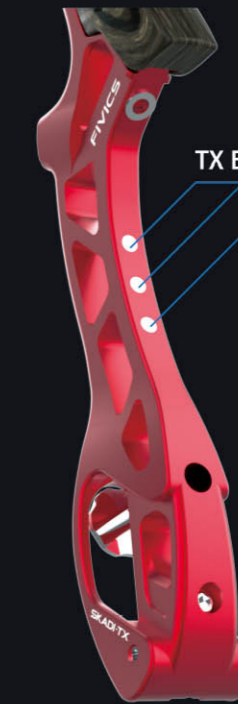

TX BALANCE SYSTEM



SKADI

SUPERB STABILITY AND ACCURACY
ACHIEVED WITH SUPER GRAPHITE



SKADI WOOD CORE LIMBS LSWC01 / **NEW**

SKADI FOAM CORE LIMBS LSFC01 / **NEW**

Super graphite carbon prepreg material / 45° carbon technology / AR tech CNC processing / The location and angle of the Power Zone has been improved

MATERIAL Super graphite **CORE** Wood core / Foam core
BOW LENGTH 66", 68", 70" **DRAW WEIGHT(lbs.)** 32#~50# (2# increments)

FIVICS limbs follow the international limb fitting system (ILF) and are guaranteed to fit in all FIVICS risers and other ILF risers.



SUPER GRAPHITE

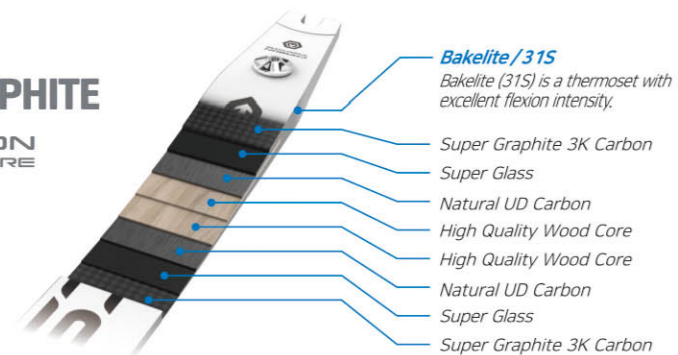

SUPER GRAPHITE

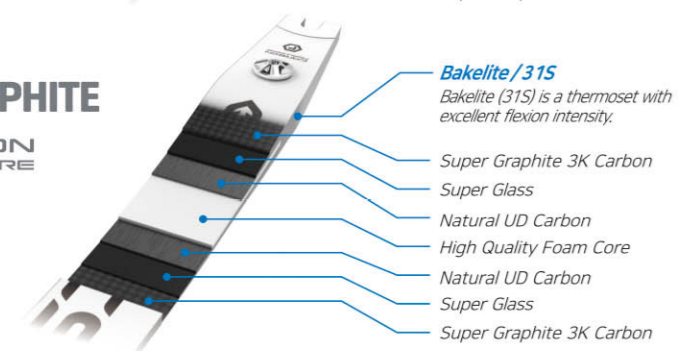

TECHNOLOGY OF FIVICS LIMBS

SUPER GRAPHITE GRAPHENE TECHNOLOGY



SUPER GRAPHITE has improved stability and accuracy compared to other carbon fiber limbs. To improve the stability and accuracy of the SKADI limb, a new material, SUPER GRAPHITE, was integrated. SUPER GRAPHITE maintains the high elasticity of carbon with reduced torsion to decrease excess vibration and offers a satisfying shooting sensation.

WHAT IS SUPER GRAPHITE?

SUPER GRAPHITE is a micrometer-sized carbon material developed as the core technology of standard graphene.

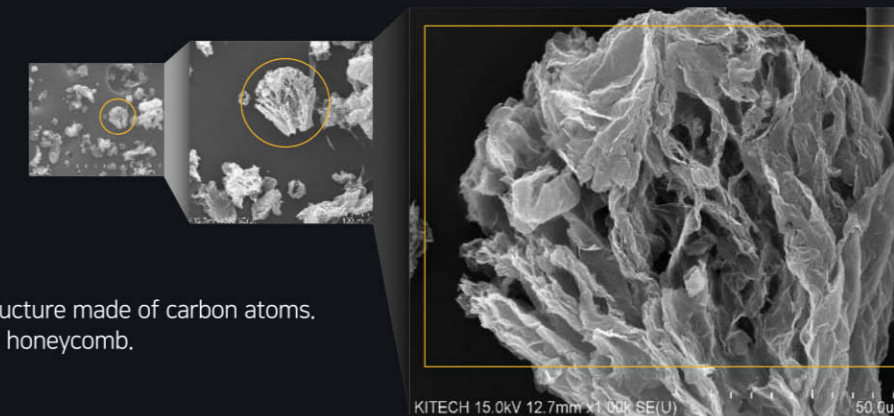

DREAM MATERIAL

Graphene is a new material with a two-dimensional planar structure made of carbon atoms. Each carbon atom forms a hexagonal lattice in the shape of a honeycomb.

Hardness
50 times stronger than steel

Flexibility
Excellent elasticity with a tensile strength of 20 GPa

Light Weight
3.2g of super graphite can cover an area of a soccer field

28" FULL DRAW DRY FIRE TEST

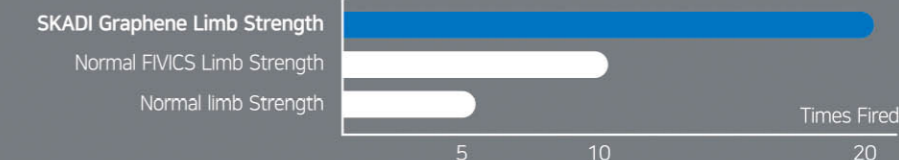

ARGON-X

FAST ARROW SPEED WITH UNIQUE HIGH-REPULSION DESIGN

ARGON-X 25" RISER **HA0725**
ARGON-X 27" RISER **HA0727 / SPECIAL**

Lower center of gravity / Fast drop from the bow hand / Superfine full CNC milling / The most precise and stable washer limb alignment system in the world with increments as low as 0.05mm / Stable & steady geometry / Tight & secure wooden grip / Deep color from anodizing

PROCESSING CNC **WEIGHT** 1,330g(25") / 1,380g(27") **MATERIAL** AL 6061
TYPE RH / LH **GRIP** TSG Wood Grip **COLOR** Anodized **LENGTH** 25", 27"

Stabilizer Mount Thread 5/16"-24 **Upstabilizer Mount Thread** 5/16"-24
Cushion Plunger Mount Thread 5/16"-24 **Clicker Mount Thread** 6/32"



Blue Sky Green Orange Red Purple Black Silver

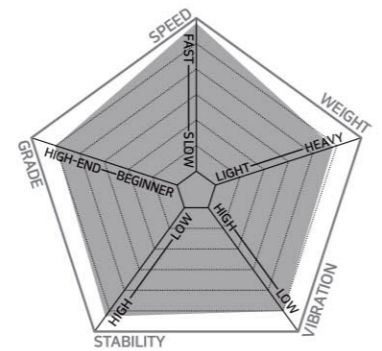

ARGON-X WOOD CORE LIMBS **LAWC01 / UPGRADE**
ARGON-X FOAM CORE LIMBS **LAFC01 / UPGRADE**

CWP3024 carbon Material / 45° carbon technology / AR tech CNC processing / The location and angle of the Power Zone has been improved

MATERIAL CWP3024 1K Full Carbon **CORE** Wood core / Foam core
BOW LENGTH 66", 68", 70"
DRAW WEIGHT(lbs.) 32#~50# (2# increments)

FIVICS limbs follow the international limb fitting system (ILF) and are guaranteed to fit in all FIVICS risers and other ILF risers.



CWP3024

1K FULL CARBON WOOD CORE

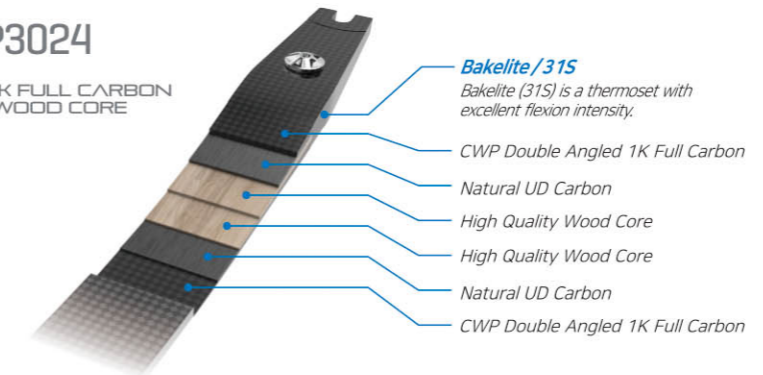

CWP3024

1K FULL CARBON FOAM CORE

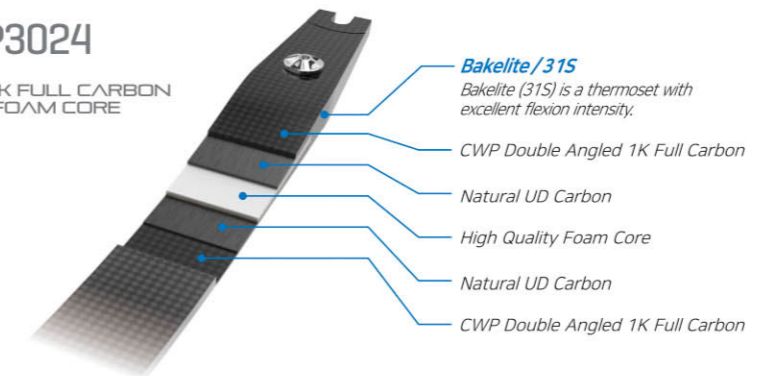

TITAN-NX

LIGHT WEIGHT & LOW VIBRATION

TITAN-NX 25" RISER HX0625

The light weight high-end riser / Superfine full CNC milling / Adjustable limb alignment with an M8 and M10 wrench without removing limbs / Stable & steady geometry / Tight & secure wooden grip / Deep color from anodizing

PROCESSING CNC **WEIGHT** 1,282g **MATERIAL** AL 6061
TYPE RH / LH **GRIP** TSG Wood Grip **COLOR** Anodized **LENGTHS** 25"

Stabilizer Mount Thread 5/16"-24 **Upstabilizer Mount Thread** 5/16"-24
Cushion Plunger Mount Thread 5/16"-24 **Clicker Mount Thread** 6/32"

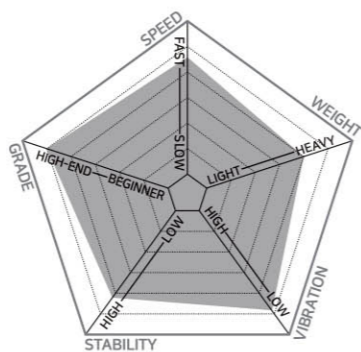

TITAN-NX WOOD CORE LIMBS LNW01 TITAN-NX FOAM CORE LIMBS LNF01

CWP240 carbon Material / 45° carbon technology / AR tech CNC processing

MATERIAL CWP240 3K Full Carbon **CORE** Wood core / Foam core
BOW LENGTH 66", 68", 70"
DRAW WEIGHT(lbs.) 32#~50# (2# increments)

FIVICS limbs follow the international limb fitting system (ILF) and are guaranteed in all FIVICS risers and other ILF risers.



CWP240

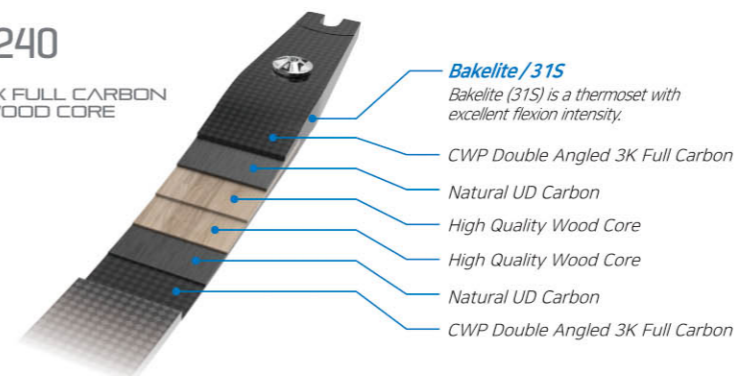

CWP240

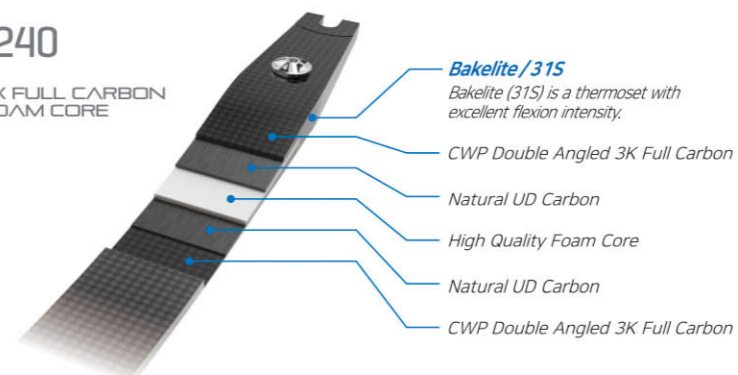

VELLATOR-V3

UNIQUELY DESIGNED RISER WITH LOW VIBRATION

VELLATOR-V3 25" RISER **HV0325**

VELLATOR-V3 23" RISER **HV0323**

High quality mid tier riser / Superfine full CNC milling / Adjustable limb alignment with an M8 and M10 wrench without removing limbs / Stable & steady geometry / Deep color from anodizing

PROCESSING CNC **WEIGHT** 1,100g(23") / 1,210g(25") **MATERIAL** AL 6061
TYPE RH / LH **GRIP** Plastic **COLOR** Anodized **LENGTH** 23", 25"

Stabilizer Mount Thread 5/16"-24 **Upstabilizer Mount Thread** 5/16"-24
Cushion Plunger Mount Thread 5/16"-24 **Clicker Mount Thread** 6/32"

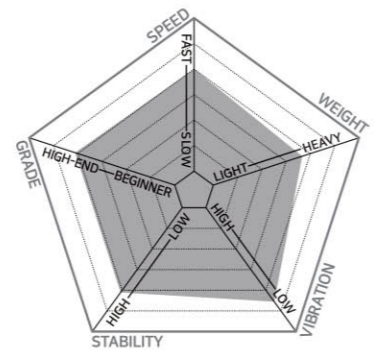

VELLATOR-V3 WOOD CORE LIMBS **LVWC0223**
VELLATOR-V3 FOAM CORE LIMBS **LVFC0223**

CUP240 carbon Material / 45° carbon technology / AR tech CNC processing

MATERIAL CUP240 Carbon **CORE** Wood core / Foam core
BOW LENGTH 66", 68", 70"
DRAW WEIGHT(lbs.) 22#~38# (2# increments)

FIVICS limbs follow the international limb fitting system (ILF) and are guaranteed in all FIVICS risers and other ILF risers.



CUP240

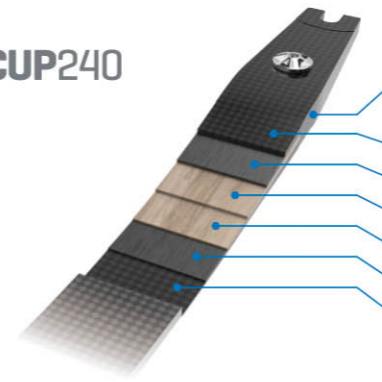

- Bakelite / 315**
Bakelite (315) is a thermoset with excellent flexion intensity.
- Fiber Glass Fabric
- Natural UD Carbon
- Hard Maple Wood
- Hard Maple Wood
- Natural UD Carbon
- Fiber Glass Fabric

CUP240

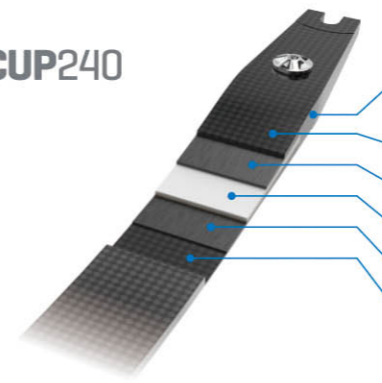

- Bakelite / 315**
Bakelite (315) is a thermoset with excellent flexion intensity.
- Fiber Glass Fabric
- Natural UD Carbon
- M-Foam Core
- Natural UD Carbon
- Fiber Glass Fabric

VELLATOR-V2

LIGHTWEIGHT RISER FOR COMPETITION

VELLATOR-V2 25" RISER **HV0225**

VELLATOR-V2 23" RISER **HV0223**

Only 1,100grams / Superfine full CNC milling / Stable & steady geometry / Deep color from anodizing

PROCESSING CNC **WEIGHT** 1,050g(23") / 1,100g(25") **MATERIAL** AL 6061
TYPE RH / LH **GRIP** Plastic **COLOR** Anodized **LENGTH** 23", 25"

Stabilizer Mount Thread 5/16"-24 **Upstabilizer Mount Thread** 5/16"-24
Cushion Plunger Mount Thread 5/16"-24 **Clicker Mount Thread** 6/32"



Blue Green Orange Red Black Silver

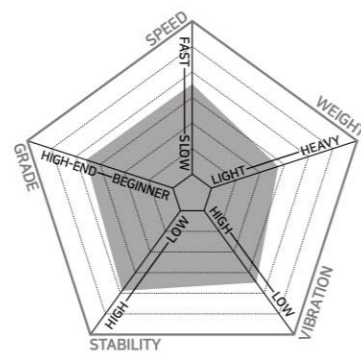

SIRASONI

SPECIAL COMPACT DESIGN

SIRASONI 17" RISER **HS0117**

Superfine full CNC milling / Adjustable limb alignment with an M8 and M10 wrench without removing limbs / Stable & steady geometry / Tight & secure wooden grip / Deep color from anodizing

PROCESSING CNC
WEIGHT 1,030g / 2.27 lbs
MATERIAL AL 6061
TYPE RH / LH **GRIP** TSG Wood Grip
COLOR Anodized **LENGTH** 17"

Stabilizer Mount Thread 5/16"-24
Cushion Plunger Mount Thread 5/16"-24



Brown Green Khaki Black



SIRASONI HUNTING LIMBS **LSW01**

CWP240 carbon Material / 45° carbon technology / AR tech CNC processing

MATERIAL CWP240 3K Full Carbon **BOW LENGTH** Medium 60" / Long 62"
DRAW WEIGHT (lbs.) 30~55 lbs in 5 lbs increments

FIVICS limbs follow the international limb fitting system (ILF) and are guaranteed to fit in all FIVICS risers and other ILF risers.

CWP240

3K FULL CARBON WOOD CORE

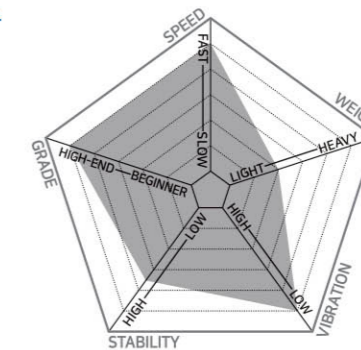
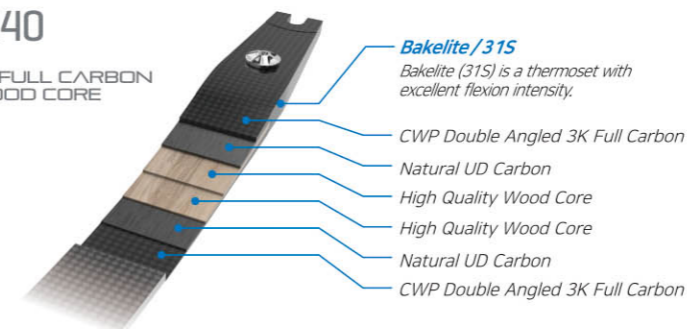

TECHNOLOGY OF FIVICS ARROW

THE WORLD'S BEST ARROW GROUPING FIVICS' FIVE-X



Through the use of tomography on arrows used in competitions around the world, FIVICS has confirmed that many arrows have internal cracks in their carbon. The Five-X arrows are constructed of MC 46TON carbon with strict quality control. They are managed with 6 times greater precision than the existing world's highest level of spine deviation, and have a 0% internal crack rate.

Grouping test with shooting machine

The FIVE-X's special carbon material and strict quality control have been proven through excellent arrow grouping. By using a shooting machine, we have formed groupings that are superior to those of other brands.

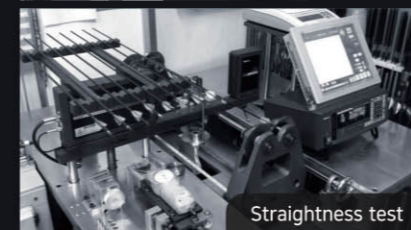
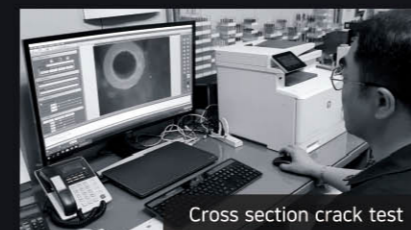

FIVE-X VS Other brand Arrows

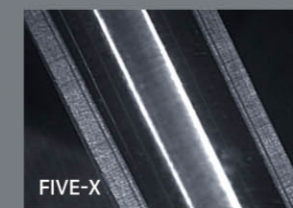

Arrow flight can be effected by carbon cracks inside the arrow. FIVE-X reduces the chance of any cracks with a special high quality carbon material, allowing for the best arrow flight.

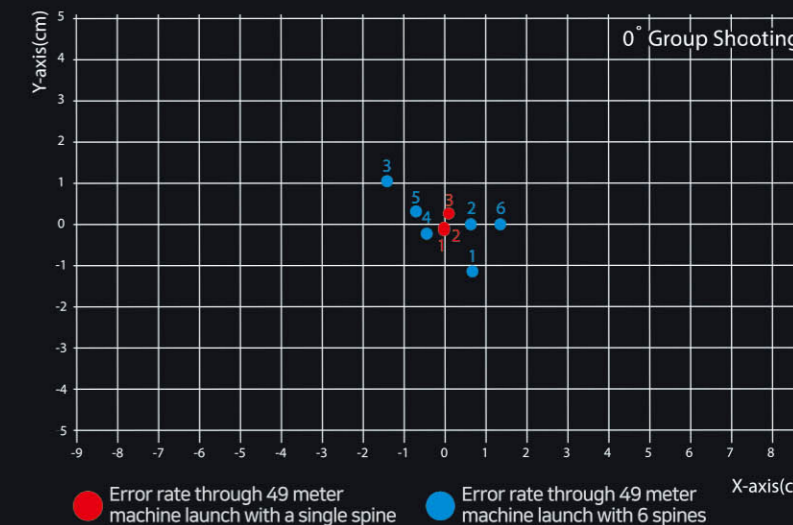

FIVE-X

FIVE-X CARBON ARROW SHAFT ARFX

Advanced Technology / Extreme Accuracy / The FIVE-X is the perfect competition arrow made with the latest carbon technology.

STRAIGHTNESS ± 0.001"
WEIGHT TOLERANCE ± 1.0 grains
SPINE SELECTION TOLERANCE ± 0.002"

FIVE-X TUNGSTEN POINT FXTPO



WEIGHT 120gr



WEIGHT 140gr

FIVE-X STAINLESS STEEL POINT FXSPO



WEIGHT 120gr

FIVE-X ALUMINUM INSERT PIN FXIN



Size	X-10 Comparison	Length	Weight (Grain)	GPI	Outside Diameter	Qty	Recommended Point Weight Range		Pin Nock Adapter	Out Nock
							Steel	Tungsten		
350	325	32"	308.3	9.63	0.2136"	12pack	1X	1X		5.0
400	325~350	32"	284.5	8.89	0.2112"	12pack				
450	350~380	32"	261.7	8.18	0.2068"	12pack				
500	410~450	31"	249.1	8.04	0.2013"	12pack	2X	2X		4.7
550	450~500	31"	216.7	6.99	0.1989"	12pack				
600	500~550	30"	201.5	6.72	0.1957"	12pack				
650	550~600	30"	193.7	6.46	0.1927"	12pack	3X	3X		4.5
700	600~650	29"	174.9	6.03	0.1898"	12pack				
750	650~700	29"	166.9	5.76	0.1895"	12pack				
800	700~750	29"	162.3	5.60	0.1864"	12pack	3X	3X		4.5
850	750~800	28"	150.2	5.36	0.1831"	12pack				
900	830	28"	144.8	5.17	0.1831"	12pack				
1000	900	28"	134.5	4.80	0.1792"	12pack				



TENPRO

TENPRO CARBON ARROW SHAFT TPROS

30ton carbon allows for extreme speed, strength, and consistency in shooting

STRAIGHTNESS ± 0.002" **WEIGHT TOLERANCE** ± 1.0 grains **SPINE SELECTION TOLERANCE** ± 0.002"

TENPRO STAINLESS STEEL POINT TPSP



WEIGHT 120gr

TENPRO ALUMINUM INSERT PIN TPPIN



Size	Length	Weight (Grain)	GPI	Outside Diameter	Qty	Recommended Point Weight Range	Pin Nock Adapter	Out Nock
400	32"	302.4	9.45	0.2354"	12pack	1T/120gr		5.48
450	32"	287.7	8.99	0.2279"	12pack			
500	31"	262.7	8.47	0.2216"	12pack			
550	31"	248.8	8.03	0.2185"	12pack	2T/120gr	1 Line	5.2
600	31"	228.9	7.38	0.2145"	12pack			
650	31"	220.5	7.11	0.2126"	12pack			
700	30"	204.6	6.82	0.2118"	12pack	3T/120gr		4.92
800	30"	186.9	6.23	0.2055"	12pack			
900	29"	164.0	5.66	0.2007"	12pack			
1000	29"	154.1	5.31	0.2004"	12pack			
1100	28"	142.2	5.08	0.1953"	12pack			
1200	28"	134.6	4.81	0.1929"	12pack			



GOLDRO

GOLDRO CARBON ARROW SHAFT GDRA

GOLDRO is the perfect target arrow for youth archers / Advanced Technology, Extreme Accuracy / The Stylish Graphics.

STRAIGHTNESS ± 0.002" **WEIGHT TOLERANCE** ± 1.0 grains
SPINE SELECTION TOLERANCE ± 0.0025"

GOLDRO STAINLESS STEEL POINT GRPO



IN NOCK NMNOK



Size	Length	Weight (Grain)	GPI	Outside Diameter	Qty	Recommended Point Weight Range	Out Nock
800	29"	199.4	6.88	0.2234"	12 pack	120gr	5.48
900	29"	184.7	6.37	0.2196"	12 pack		
1000	28"	169.7	6.06	0.2172"	12 pack		
1100	28"	161.7	5.78	0.2151"	12 pack		
1200	28"	155.6	5.56	0.2135"	12 pack	110gr	2100
1300	28"	146.5	5.23	0.2109"	12 pack		
1400	28"	141.3	5.05	0.2096"	12 pack		
1500	28"	131.2	4.69	0.2082"	12 pack		
1600	28"	120.2	4.29	0.2049"	12 pack		5.2



ZEILO

ZEILO CARBON ARROW SHAFT ZLA

ZEILO is the target arrow for youth archers / Advanced Technology, Extreme Accuracy.

STRAIGHTNESS ± 0.002" **WEIGHT TOLERANCE** ± 1.0 grains **SPINE SELECTION TOLERANCE** ± 0.0025"

ZEILO STAINLESS STEEL POINT



ZEILO ALUMINUM INSERT PIN



Size	Length	Weight (Grain)	GPI	Outside Diameter	Qty	Recommended Point Weight Range
500	30"	303.8	10.13	0.2515"	12 pack	110gr / 120gr
600	30"	280.3	9.34	0.2490"	12 pack	110gr / 120gr
700	30"	232.9	7.76	0.2455"	12 pack	110gr / 120gr
800	29"	221.3	7.63	0.2412"	12 pack	110gr / 120gr
900	29"	209.4	7.22	0.2386"	12 pack	110gr / 120gr
1000	28"	198.0	7.07	0.2372"	12 pack	110gr / 120gr
1100	28"	185.0	6.61	0.2352"	12 pack	110gr / 120gr
1200	28"	183.3	6.55	0.2339"	12 pack	110gr / 120gr
1300	28"	178.7	6.38	0.2333"	12 pack	110gr / 120gr
1400	28"	161.7	5.78	0.2317"	12 pack	110gr / 120gr
1500	28"	156.6	5.59	0.2303"	12 pack	110gr / 120gr



FIVICS ARROWS SELECTION GUIDE

FX : FIVE-X
TP : TENPRO
GR : GOLDRO
ZL : ZEILO

Total Arrow Length	16~lbs.	18~lbs.	20~lbs.	22~lbs.	24~lbs.	26~lbs.	28~lbs.	30~lbs.	32~lbs.
24"			GR1600 ZL1500	GR1600 ZL1500	GR1500 ZL1500	GR1400 ZL1400	GR1300 ZL1300	GR1200 ZL1200	TP1200 GR1100 ZL1100
25"		GR1600 ZL1500	GR1600 ZL1500	GR1500 ZL1500	GR1400 ZL1400	GR1300 ZL1300	GR1200 ZL1200	TP1200 GR1100 ZL1100	TP1100 GR1000 ZL1000
26"	GR1600 ZL1500	GR1600 ZL1500	GR1500 ZL1500	GR1400 ZL1400	GR1300 ZL1300	GR1200 ZL1200	TP1200 GR1100 ZL1100	TP1100 GR1000 ZL1000	FX1000 TP1000 GR900 ZL900
27"	GR1600 ZL1500	GR1500 ZL1500	GR1400 ZL1400	GR1300 ZL1300	GR1200 ZL1200	TP1200 GR1100 ZL1100	TP1100 GR1000 ZL1000	FX1000 TP1000 GR900 ZL900	FX1000 TP900 GR900 ZL900
28"	GR1500 ZL1500	GR1400 ZL1400	GR1300 ZL1300	GR1200 ZL1200	TP1200 GR1100 ZL1100	TP1100 GR1000 ZL1000	FX1000 TP1000 GR900 ZL900	FX1000 TP900 GR900 ZL900	FX900 TP800 GR800 ZL800
29"	GR1400 ZL1400	GR1300 ZL1300	GR1200 ZL1200	TP1200 GR1100 ZL1100	TP1100 GR1000 ZL1000	FX1000 TP1000 GR900 ZL900	FX1000 TP900 GR900 ZL900	FX900 TP800 GR800 ZL800	FX900 TP800 GR800 ZL800
30"	GR1300 ZL1300	GR1200 ZL1200	TP1200 GR1100 ZL1100	TP1100 GR1000 ZL1000	FX1000 TP1000 GR900 ZL900	FX1000 TP900 GR900 ZL900	FX900 TP800 GR800 ZL800	FX900 TP800 GR800 ZL800	FX850 TP700 ZL700
31"	GR1200 ZL1200	TP1200 GR1100 ZL1100	TP1100 GR1000 ZL1000	FX1000 TP1000 GR900 ZL900	FX1000 TP900 GR900 ZL900	FX900 TP800 GR800 ZL800	FX900 TP800 GR800 ZL800	FX850 TP700 ZL700	FX800 TP700 ZL700
32"	TP1200 GR1100 ZL1100	TP1100 GR1000 ZL1000	FX1000 TP1000 GR900 ZL900	FX1000 TP900 GR900 ZL900	FX900 TP800 GR800 ZL800	FX900 TP800 GR800 ZL800	FX850 TP700 ZL700	FX800 TP700 ZL700	FX750 TP650 ZL600
33"	TP1100 GR1000 ZL1000	FX1000 TP1000 GR900 ZL900	FX1000 TP900 GR900 ZL900	FX900 TP800 GR800 ZL800	FX900 TP800 GR800 ZL800	FX850 TP700 ZL700	FX800 TP700 ZL700	FX750 TP650 ZL600	FX700 TP600 ZL600
34"	FX1000 TP1000 GR900 ZL900	FX1000 TP900 GR900 ZL900	FX900 TP800 GR800 ZL800	FX900 TP800 GR800 ZL800	FX850 TP700 ZL700	FX800 TP700 ZL700	FX750 TP650 ZL600	FX700 TP600 ZL600	FX650 TP550 ZL500

Total Arrow Length	34~lbs.	36~lbs.	38~lbs.	40~lbs.	42~lbs.	44~lbs.	46~lbs.	48~lbs.	50~lbs.	52~lbs.	54~lbs.	56~lbs.
24"	TP1100 GR1000 ZL1000	FX1000 TP1000 GR900 ZL900	FX1000 TP900 GR900 ZL900	FX900 TP800 GR800 ZL800	FX900 TP800 GR800 ZL800	FX850 TP700 ZL700	FX800 TP700 ZL700	FX750 TP650 ZL600	FX700 TP600 ZL600	FX650 TP550 ZL500	FX600 TP500 ZL500	FX550 TP450
25"	FX1000 TP1000 ZL900	FX1000 TP900 GR900 ZL900	FX900 TP800 GR800 ZL800	FX900 TP800 GR800 ZL800	FX850 TP700 ZL700	FX800 TP700 ZL700	FX750 TP650 ZL600	FX700 TP600 ZL600	FX650 TP550 ZL500	FX600 TP500 ZL500	FX550 TP450	FX500 TP400
26"	FX1000 TP900 GR900 ZL900	FX900 TP800 GR800 ZL800	FX900 TP800 GR800 ZL800	FX850 TP700 ZL700	FX800 TP700 ZL700	FX750 TP650 ZL600	FX700 TP600 ZL600	FX650 TP550 ZL500	FX600 TP500 ZL500	FX550 TP450	FX500 TP400	FX450
27"	FX900 TP800 GR800 ZL800	FX900 TP800 GR800 ZL800	FX850 TP700 ZL700	FX800 TP700 ZL700	FX750 TP650 ZL600	FX700 TP600 ZL600	FX650 TP550 ZL500	FX600 TP500 ZL500	FX550 TP450	FX500 TP400	FX450	FX400
28"	FX900 TP800 GR800 ZL800	FX850 TP700 ZL700	FX800 TP700 ZL700	FX750 TP650 ZL600	FX700 TP600 ZL600	FX650 TP550 ZL500	FX600 TP500 ZL500	FX550 TP450	FX500 TP400	FX450	FX400	FX350
29"	FX850 TP700 ZL700	FX800 TP700 ZL700	FX750 TP650 ZL600	FX700 TP600 ZL600	FX650 TP550 ZL500	FX600 TP500 ZL500	FX550 TP450	FX500 TP400	FX450	FX400	FX350	
30"	FX800 TP700 ZL700	FX750 TP650 ZL600 NJ600	FX700 TP600 ZL600 NJ600	FX650 TP550 ZL500 NJ500	FX600 TP500 ZL500 NJ500	FX550 TP450 NJ400	FX500 TP400	FX450	FX400	FX350		
31"	FX750 TP650 ZL600	FX700 TP600 ZL600	FX650 TP550 ZL500	FX600 TP500 ZL500	FX550 TP450	FX500 TP400	FX450	FX400	FX350			
32"	FX700 TP600 ZL600	FX650 TP550 ZL500	FX600 TP500 ZL500	FX550 TP450	FX500 TP400	FX450	FX400	FX350				
33"	FX650 TP550 ZL500	FX600 TP500 ZL500	FX550 TP450	FX500 TP400	FX450	FX400	FX350					
34"	FX600 TP500 ZL500	FX550 TP450	FX500 TP400	FX450	FX400	FX350						



TUNGSTEN POINT

FIVE-X TUNGSTEN POINT **FXTPO**



FIVICS TUNGSTEN POINT TO FIT EASTON X10 ARROWS

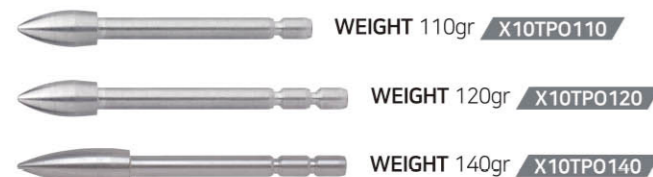

Fivics Tungsten Points are not an official licensed product of Easton Technical Products, Inc. X10 is a registered trademark of Easton Technical Products, Inc.

FINEST PRECISION TUNGSTEN POINT

FIVICS has developed the finest precision tungsten point with the world's best precision processing technology. More precise points make better groupings.

Contents	Other brand	FIVICS Tungsten Point
Weigh	118.8gr~121.5gr	119.7~120.3gr
Length	47.27mm~47.84mm	± 0.1
Diameter	3.13mm~3.20mm	No difference
Price		Cheaper than other brands
More information	Rough Surface Hardness is too high making it is easy to break	Smooth Surface Has moderate hardness, so it doesn't break easily

WEIGH

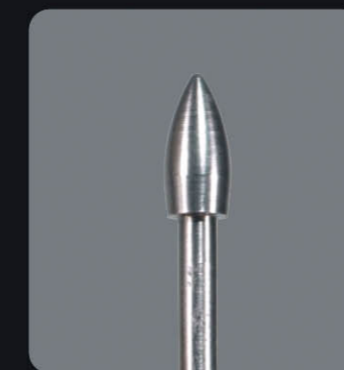

Other brand

VS

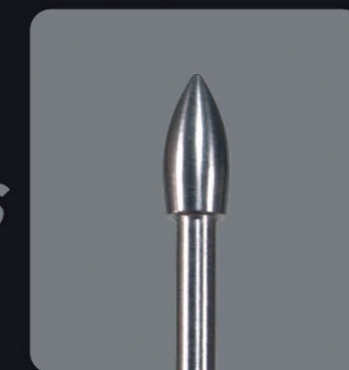

FIVICS Tungsten Point



ARROW ACCESSORIES

X-NET STAINLESS STEEL POINT TO FIT EASTON X10 ARROWS



WEIGHT 110gr XNET10110



WEIGHT 120gr XNET10120

Fivics X-net Stainless Steel Points are not an official licensed product of Easton Technical Products, Inc. X10 is a registered trademark of Easton Technical Products, Inc.



REVERPIN NOCK ADAPTER

REVERPIN

Designed for X-10 arrows



Red Gold Blue

PIN NOCK (S) NC001S

PIN NOCK (L) NC001L

This universal pin nock fits all standard pin nock adapters. It is made from a durable polycarbonate material that performs shot after shot.

AVAILABLE IN TWO SIZE S fits 12-18 strand strings / L fits 20-24 strand strings

OPQ



Pink Yellow White

CLEAR



Red Orange Green Blue Purple Pink

TECHNOLOGY OF FIVICS STABILIZER



SKADI-BX



SUPERIOR AIMING STABILITY AND VIBRATION DAMPENING

- SKADI-BX** STABILIZER LONG **SKBXRL** **NEW**
- SKADI-BX** STABILIZER SIDE **SKBXRCS** **NEW**
- SKADI-BX** STABILIZER EXTENDER **SKBXRCE** **NEW**

The SKADI-BX stabilizers are manufactured with an advanced blow method to highlight the strengths of the carbon shaft. This method of construction increases the specific gravity of the carbon fiber rather than that of the resin, which greatly strengthens the physical properties of the stabilizer while also allowing for more energy to be absorbed. The crosswind zero design enables stable aiming even in unpredictable winds, and the tip of the stabilizer has a thicker diameter to increase vibration reduction.

MATERIAL Super graphite carbon prepreg **DIAMETER** 13.5mm
LENGTH Long : 26", 28", 30" / Side : 10", 11", 12", 15" / Extender : 3", 4", 5"
WEIGHT 172g(28"), 98g(12")

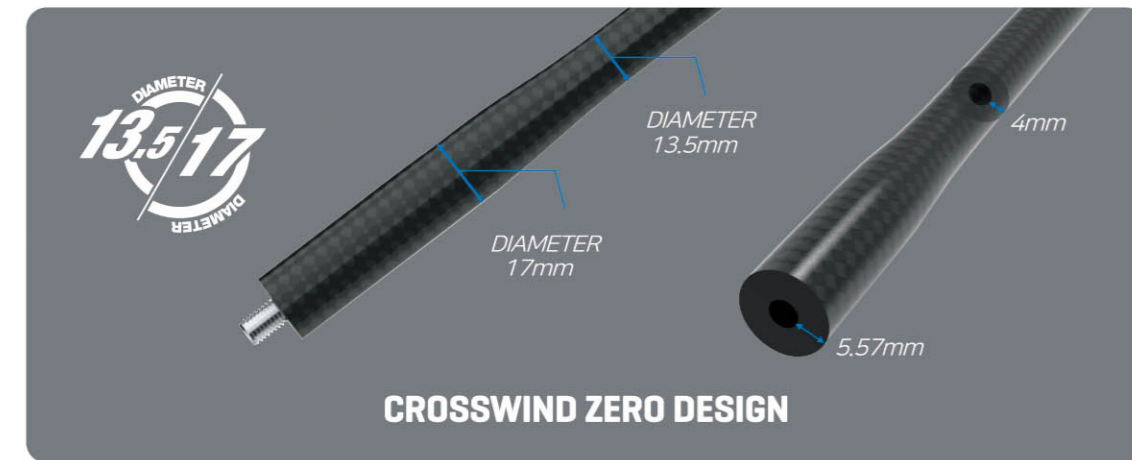

TECHNOLOGY OF FVICS STABILIZER

CARBON STABILIZERS CRAFTED WITH BLOW MOLDING TECHNOLOGY

Through blow molding, the front cap of the stabilizer is integrated into the rest of the shaft without the need of installing an aluminum cap. The SKADI-BX Stabilizers feature improved physical properties by having a reduced resin content and increased raw oil content, which differs from previously existing stabilizers. The inside and outside of the stabilizer is composed of a fabric (plain weave) carbon pattern to improve durability. The vibration damping effect is increased through integrally molding the tip of the stabilizers with full carbon.

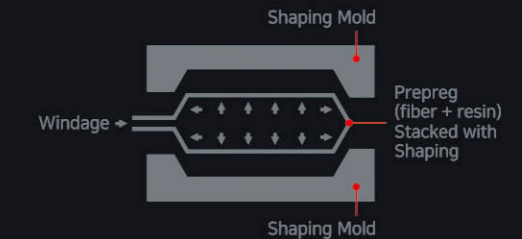

SUPER GRAPHITE GRAPHENE TECHNOLOGY

SUPER GRAPHITE is a carbon prepreg material that has evolved further from graphene, a next-generation new material, featuring a greatly improved the vibration absorption rate compared to previous stabilizer technology.

SUPER GRAPHITE is a micrometer-sized carbon material developed as the core technology of standard graphene.

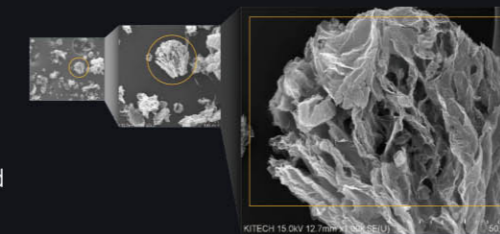

Graphene is a new material with a two-dimensional planar structure made of carbon atoms. Each carbon atom forms a hexagonal lattice in the shape of a honeycomb.

- Hardness**
50 times stronger than steel
- Flexibility**
Excellent elasticity with a tensile strength of 20 GPa
- Light Weight**
3.2g of super graphite can cover an area of a soccer field

FORNIX 14

1K HIGH-ELASTIC CARBON TECHNOLOGY

FORNIX 14 STABILIZER LONG SF14RCL

FORNIX 14 STABILIZER SIDE SF14RCS

FORNIX 14 STABILIZER EXTENDER SF148RCE

The FORNIX 14 Stabilizer's outer circumference is 14mm and is 4mm thick of high-elastic carbon (carbon fiber). This new stabilizer is unique because it uses specially produced carbon fabric (only applied to FIVICS products), which focuses on the dampening of vibration.

MATERIAL 40ton Carbon **DIAMETER** 14.5mm
EXTENDER DIAMETER 18mm
LENGTH Long : 26", 28", 30" / Side : 10", 11", 12", 13", 15" / Extender : 4", 5"
WEIGHT 190g(28"), 108g(12")



Carbon White

TECHNOLOGY OF FIVICS STABILIZER

1K HIGH-ELASTIC CARBON TECHNOLOGY FORNIX STABILIZER

The FORNIX Stabilizer is formed by the efficient layering of General Modulus Carbon into High Modulus Carbon. This build is characterized as highly elastic and having a very strong spine relative to the weight of the unit. Fivics also uses the high-pressure mold method to diminish the presence of resins (foreign substances and impurities), maximize carbon purity density, and minimize residual and unwanted vibrations.

The FIVICS specific DAMPER uses high-quality butyl as an ingredient to develop a mixing ratio which can reduce vibrations up to 100%.

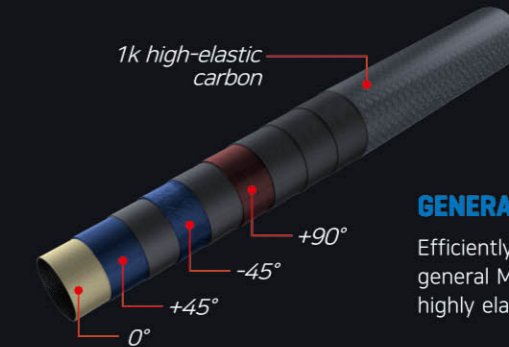

GENERAL MODULUS CARBON

Efficiently layered by general Modulus carbon highly elastic and very strong spine

FORNIX14 VS FORNIX18 VS CEX1900

The FORNIX14, FORNIX18, and CEX1900 Stabilizers have been tested with the 3-axis acceleration test and the ultra-high-speed vibration tracking test, which proved the FORNIX stabilizers have a superior carbon material and design compared to the CEX1900.

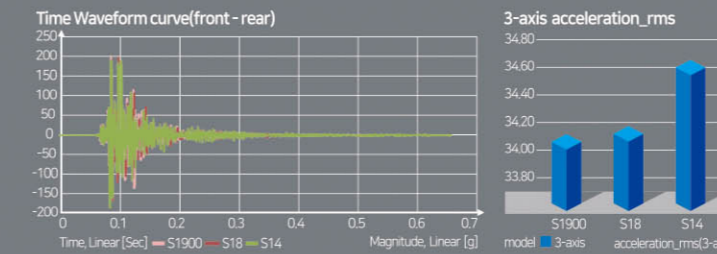

STABILIZER SCREW TAB

by adding a screw indent to the carbon attachment point, the coupling force of the joint connecting the carbon stabilizer to the end cap is stronger.

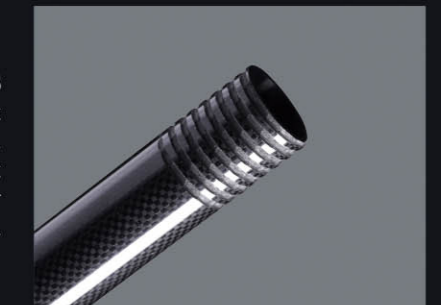

BTR100

Fivics produced 100 sample dampers each with different rubber blending ratios and shapes to determine the best combination and consistency. we found the following products achieve the best performance out of all the blending ratios, so we designated this rubber as brt100 and apply it to all of our damper products.



VELLATOR

- VELLATOR STABILIZER LONG** STV01L
- VELLATOR STABILIZER SIDE** STV01S
- VELLATOR STABILIZER EXTENDER** STV02E

The VELLATOR STABILIZER orients and builds General Modulus Carbon into the ideal stabilizer for intermediate archers. In addition to high elasticity and strong spine per weight, the VELLATOR STABILIZERS also come in multiple vibrant color saturations. Including special laminating materials / Damper and weight head included / Absorbing noise system stabilizer + damper + weight head

MATERIAL 24ton Carbon **DIAMETER** 18mm
LENGTH Long : 26", 28", 30" / Side : 9", 10", 12" / Extender : 3", 4"(Aluminum)
WEIGHT 134g(28"), 84g(12")



STABILIZER ACCESSORIES

LOK V-BAR VBLOK02R

Locked on Kinetics! This new V-Bar has a reduced vibration with stable performance.

ANGLE 35° / 40° / 45°
MATERIAL Aluminum



COM CONNECTING BOLT VBCOC

Quick disconnection
ANGLE 10°
MATERIAL Aluminum



PX1500 WEIGHT WT15004

DIAMETER 29mm
WEIGHT 26g / 52g / 104g
THREAD 1/4"-20



WT WEIGHT

DIAMETER 20mm **THREAD** 1/4"-20
WEIGHT Head-40g / Flat-26g



CONVERTER SCREW

Applicable for all dampers



DC1500S DAMPER DC1500S

Using special rubber IIR
THREAD 1/4"-20



DC1500 DAMPER DC1500

THREAD 1/4"-20



V-ZERO DAMPER VZEROL

THREAD 1/4"-20



V-ZERO MINI DAMPER VZEROM

THREAD 1/4"-20



AIREX



AIREX CUSHION PLUNGER AACP

Dial checking
Pressure point material : **Hastelloy**

THREAD 5/16"-24
ADJUSTABLE LENGTH Min 19,5mm, Max 26,5mm



Red Blue Silver Black



TECHNOLOGY OF FMICS CUSHION PLUNGER

NEW MATERIAL HASTELLOY

HASTELLOY PRESSURE POINT

What is Hastelloy?

Hastelloy offers exceptional resistance to strong oxidizing solutions, strong durability in reducing environments, and a low carbon content that provides minimization of grain-boundary carbide precipitation.

What is Corrosion resistance?

Corrosion resistance refers to the resistance a material offers against a reaction with adverse elements that can corrode the material. Various materials have this property intrinsically, depending upon their corrosion resistance rate.

Hastelloy minimizes corrosion when the arrow shaft touches the cushion plunger during arrow flight and makes the arrow fly more stable with greater grouping. We apply this high-end material to the new cushion plunger "Airex".

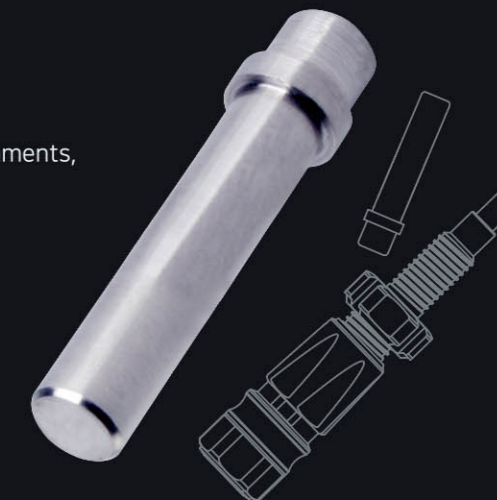

6000 TIMES SHOT ABRASION TEST

After installing on the cushion plunger test equipment, measurements of the friction were taken 3 times for each material, repeated 2,000 times. Measurements of the abrasion of the arrow surface and abrasion of the pressure point per number of time were also collected.

Material 1 : Hastelloy Pressure Point
Material 2 : Aluminum Pressure Point

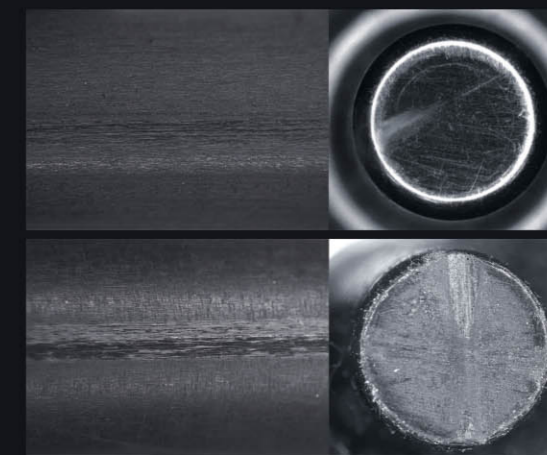

HASTELLOY Pressure point

Arrow Shaft Surface / Pressure Point :
6000 times shot abrasion test

- Arrow Shaft Surface Abrasion : Almost None.
- Pressure Point Abrasion : Almost None.

ALUMINUM Pressure point

Arrow Shaft Surface / Pressure Point :
2000 times shot abrasion test

- Arrow Shaft Surface Abrasion : High
- Pressure Point Abrasion : High



SM540

SM540 CUSHION PLUNGER SM540

Compact size for easy setting

THREAD 5/16"-24

ADJUSTABLE LENGTH Min 19.5mm, Max 26.5mm



Red

Blue

Silver

Black



FV-300S

FV-300S SIGHT FV300S

Designed for Olympic style / Recurve bows / Specially designed weight and dampers available (included) / VTS (Variable Tension System) / Elevation travel tension adjustment

SIZE Extention 9" TYPE RH MATERIAL Aluminum, Carbon



SIGHT DAMPERS

Specially designed weight and damper included



FVW502

FVW501

SIGHT PIN (SQUARE) SGP01S



SIGHT PIN (ROUND) SG001R



Designed for Olympic style recurve bows / Fit for all sights

CLICKER · REST

CRYSTAL CLICKER FCSCLO1 NEW

MATERIAL POLYCARBONATE
 SIZE 101 X 1.5mm
 THICKNESS 1.5mm



OUT-NOCK REST RS03

This arrow rest is optimized for out-nock arrows to stay on the rest without concerns for the arrow dropping. The out-nock arrow rest gives maximum clearance for all nock types.



RS REST RS02

Compatible with all nock types.



UPSTABILIZER

TNV2300 UPSTABILIZER TNV2300

Reduces vibrations within the riser.

WEIGHT 86g THREAD 5/16"-24



TNS100AL UPSTABILIZER TNS100AL

Reduces vibrations within the riser.

WEIGHT 90g THREAD 5/16"-24



AUTOMATIC BOW STAND (SHORT)
ST001S

HEIGHT 44cm
WEIGHT 573g
MATERIAL Aluminum



AUTOMATIC BOW STAND (LONG)
ST001L

HEIGHT 65cm
WEIGHT 680g
MATERIAL Aluminum



AUTOMATIC SYSTEM

CARBON T-GAUGE BOW SQUARE AC05CT MATERIAL Carbon

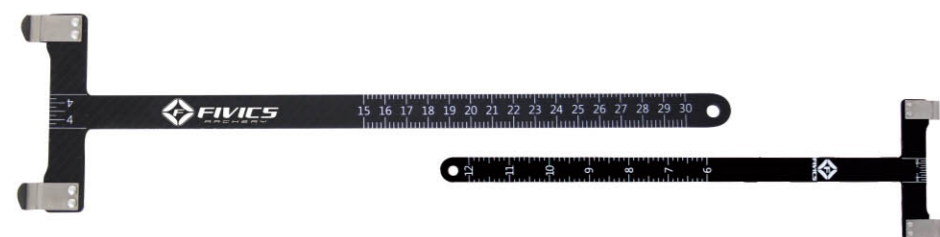

TECHNOLOGY OF FIVICS FINGER TABS



TENFIX LOCK-IN ON THE 10



6D
ADJUSTABLE IN
THREE AXIS AND
SIX DIRECTIONS

TENFIX FINGER TAB SFT05A

SIZE L / M / S / XS (RH / LH) WEIGHT M 90g LEATHER Cordovan

The world's most customizable finger tab.

The TENFIX finger tab is designed in collaboration with the nationally renowned coach, Kwon Yong-Hak.

Coach Kwon is praised as one of the best coaches in China because he has produced amazing results as a coach.

The TENFIX finger tab's body is a smooth design which incorporates the function of the Saker Finger Tab series' EP system.

PATENTED

FIVICS Collaboration

Kwon Yonghak

The 9mm-thick aluminum plate provides the best adhesion to the hand and a thumb and little finger supporter can be adjusted in 3 axis and 6 directions.

This is the most customizable finger tab in the world, with elements to best suit your hands, and includes the most natural and accurate hooking sensation to increase shooting accuracy.

ADJUSTABLE IN THREE AXIS AND SIX DIRECTIONS

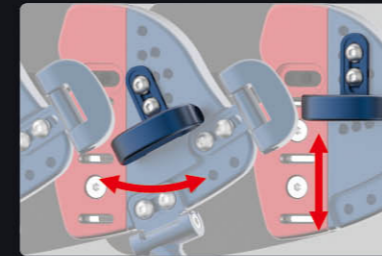

Thumb rest can be raised, lowered, and pivoted left and right



Chin rest can be raised, lowered, and pivoted left and right



Chin Shelf can be pivoted up and down



Pinky rest can be adjusted front and back



Pinky rest can be pivoted left and right



Fingertab strap can be adjusted to fit only the middle finger or both the ring and middle fingers

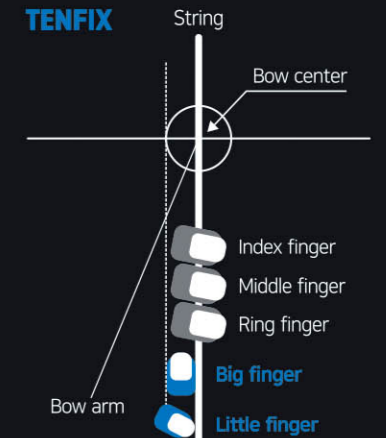

SAKER

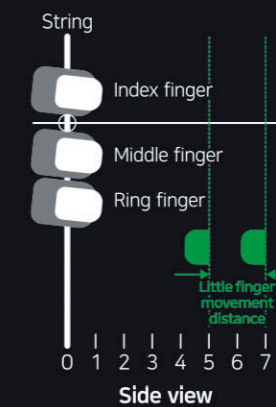

TENFIX

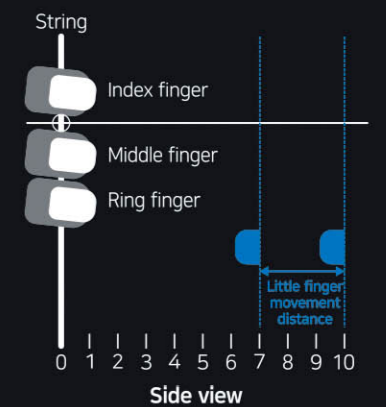

Pinky Rest has greater adjustability compared to the Saker Finger Tab



SAKER SERIES

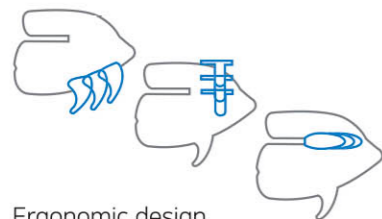

Ergonomic design
Adjustable ledge
Replaceable face and backing
Finger spacer included



SAKER 1 FINGER TAB
SFT01A

SIZE XL / L / M / S / XS / XXS (RH / LH)
LEATHER Cordovan
COLOR XL L M S XS XXS



SAKER 2 FINGER TAB
SFT02A

SIZE XL / L / M / S / XS / XXS (RH / LH)
LEATHER Cordovan
COLOR XL L M S XS XXS



SAKER 3 FINGER TAB
SFT03A

SIZE L / M / S (RH / LH)
LEATHER Cordovan
COLOR L M S

SAKER FINGER TAB SIZE GUIDE

	XL 210mm~	S 175~185mm
	L 195~210mm	XS 165~175mm
	M 185~195mm	XXS ~165mm

BRASS SAKER 1 FINGER TAB
BFT01A

SIZE L / M / S (RH / LH)
WEIGHT L 162g, M 152g, S 144g
LEATHER Cordovan



BRASS SAKER 2 FINGER TAB
BFT02A

SIZE L / M / S (RH / LH)
WEIGHT L 150g, M 140g, S 136g
LEATHER Cordovan



SAKER 1 FINGER TAB FRAME EP EP002

The Frame EP offers top shooters another reference for their hooking direction to allow for the most comfort and balance. This component enhances the Saker Finger Tab's Ergonomic design.

SIZE saker1 XL, L = EP (L size) / saker1 M, S = EP (M size) / saker1 XS, XXS = EP (S size)

WA RULES Book3, Chapter 11, Article 11.18

The Technical Committee concluded that if the bar extends to the wrist but not beyond (extends at or before the contact point between the hand and the wrist), then the extension is legal. World Archery C&R Committee, 22 September 2014

SAKER PLUS FINGER TAB /SFT04AN

SIZE L / M / S (RH is new model, but LH is old version in 2016)

Saker Plus finger tab is 4mm thick, allows 3 weight control systems and 5 angle adjustment system through precise machining of the aluminum plate. Saker Plus finger tab can be adjusted to fit the archers shape and preference to allow more stable hooking position, making it the best tab to shoot perfectly in any competition.

- 1. Angle Adjustment
- 2. Adjustable Ledge
- 3. Weight Control
- 4. Balance Control



POLITE 3 FINGER TAB
NEWPFT03

SIZE L / M / S (RH / LH)
COLOR Champagne Gold
LEATHER Cordovan



POLITE 2 FINGER TAB
NEWPFT02

SIZE L / M / S (RH / LH)
COLOR Champagne Gold
LEATHER Cordovan



Emphasizes the sense of unity in your hands. / Absolute stability, accuracy, and sense of unity of hooking / 5 Distribution and support of the optimal force by using the whole fingers / Ergonomic 3D design / Aluminum & anodizing surface treatment

FALCON FINGER TAB /FLFT01 /NEW

After 20 years of innovation in Olympic Archery, we are now releasing our first finger tab for Barebow archers! The FALCON finger tab provides absolute stability and unity between the archer and the bow.

SIZE L / S (RH / LH)
COLOR BLACK
LEATHER CORDOVAN



FINGER SPACER

THIN SPACER
FS004T

MATERIAL Rubber
SIZE 32 x 28 x 12.4mm



PLASTIC SPACER
FS001P

MATERIAL Plastic
SIZE 36 x 28.3 x 12.3mm



PRO SPACER
FS007D

MATERIAL Rubber
SIZE 46 x 28.6 x 13mm



PRO SPACER(Oval)
FS007O

MATERIAL Rubber
SIZE 41 x 26 x 13.4mm



THICK SPACER
FS004D

MATERIAL Rubber
SIZE 39.8 x 29.3 x 16.2mm



PROTECTORS

WIND CHEST GUARD **CG02BP**

Ergonomic chest guard made of hard mesh and high quality HOOK AND LOOP.

SIZE XL, L, M, S TYPE RH



A2 CHEST GUARD **CG001A2**

Adjustable shoulder band / The secure button strap can be adjusted to size

SIZE L(From XL to M), M(From L to S), S(From M to XS) TYPE RH / LH



ORGANIC X ARMGUARD

AMX01

Lightweight and comfortable design Durable plastic for better protection



ORGANIC WEB ARMGUARD

AM001

Lightweight and durable plastic armguard



HARNESS SILICON JELLY ARMGUARD

AMH01

Accidental string contact with the Silicon Jelly Armguard minimizes unwanted vibration and repulsion during the shot while protecting the bow arm.



LIMB PROTECTOR **AC21LP**

New Design / Protects the tip of your shoes while holding the bow at rest.

SIZE 56 x 97mm MATERIAL Rubber



UNICO SERIES

UNICO BACK QUIVER QV01UNB

Elegantly crafted quiver made with artificial leather

WEIGHT 380g TYPE RH



UNICO TOURNAMENT QUIVER L QV01UNL

SIZE Large WEIGHT 502g TYPE RH

Elegantly crafted quiver made with artificial leather



UNICO TOURNAMENT QUIVER S QV01UNS

SIZE Small WEIGHT 418g TYPE RH



ACCENDO SERIES

ACCENDO BACK QUIVER QV02AB

Lightweight / Large pocket for accessories

WEIGHT 260g TYPE RH



ACCENDO TOURNAMENT QUIVER QV02AT

Lightweight / Large pocket for accessories

WEIGHT 630g TYPE RH



AEGIS SERIES

AEGIS TWO BOW HARD CASE BCH01

High quality hard case / This model can hold up to two recurve bows and their accessories

SIZE 33 x 15 x 10" MATERIAL ABS+PC WEIGHT 8.4kg

Recommended maximum weight : 23kg



Red Orange Blue White Black

Case belt / Rain cover included



AEGIS ONE BOW HARD CASE BCH02

Lightweight / Strong against rough handling / Specially designed wheels / Showy colors / This model can hold up to one recurve bow and its accessories.

SIZE 32.5 x 12.6 x 7.5" MATERIAL ABS+PC WEIGHT 6.5kg

Recommended maximum weight : 23kg



Red Orange Blue White Black

Case belt / Rain cover included



THUNDER-M

THUNDER-M COMPOUND CASE (TOW BOW) BCCTHM

Room for two compound bows

DIMENSION 15 x 45 x 12"

Recommended maximum weight : 23kg



TENTRON-M

TENTRON-M BACKPACK BCB02TM

Riser & Limbs case included / Arrow tube included

SIZE 11.8 x 7.8 x 26.7" **POCKET** 1pcs **WEIGHT** 2.4kg



FOLDING CASE (2 LEVEL) **BC2L01**

Compact size! Includes compartments for risers, limbs, and accessories

SIZE 28.5 x 10.5 x 1.5" WEIGHT 900g



RECURVE RISER PROTECTOR

RAC22RP / NEW

SIZE 24.8 x 4.1" WEIGHT 200g



RISER & LIMBS CASE **RLC01**

SIZE 27 x 7.5 x 3" WEIGHT 800g



TOOL BOX **EC03**

SIZE 8.5 x 7 x 7"



FIVICS ARROW TUBE

EC04AT



EC04AK

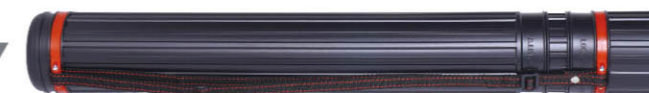

PRO HAND POCKET **STPR01**

SIZE 5 x 2.5 x 6" WEIGHT 80g



ARROW PULLER **AC24PU**

Non-slip pattern ensures a strong grip





TEAM FIVICS SHOOTER JERSEY

AC22SJBL

SIZE S / M / L / XL / XXL / XXXL



COOL ARM SLEEVE AC26CS



FIVICS LOGO TEE AC22TE

SIZE M / L / XL / XXL / XXXL



FIVICS LOGO CAP NAVY

AC22CANV



FIVICS LOGO CAP WHITE

AC14CAWT **NEW**



FIVICS BUCKET HAT

AC22BHWT

SIZE 56 / 58

FIVICS LOGO SOCKS

AC17SOMN / AC17SOWN



STRETCH BAND LIGHT (YELLOW)

AC03SL

Quality, natural rubber latex construction

THICKNESS 0.3mm



STRETCH BAND HEAVY (BLUE)

AC03SH

Quality, natural rubber latex construction

THICKNESS 0.4mm



TARGET SCORE BOOK / PAG001

SIZE 85 x 130mm PAGE 20p COVER Hard



CLOCK / AC04CL

SIZE 260 x 260 x 47mm



FIVICS UMBRELLA / UMBL02

LENGTH 80cm
OPENED SIZE 1m 20cm



TARGET FACE UMBRELLA / UMBL01

LENGTH 1m
OPENED SIZE 1m 60cm



PERFECT TARGET FACE



Waterproof 

MASTERPIECES

World famous craftsmanship. Researched and tested to be the perfect target faces for competitions.

MATERIAL Polyester THICKNESS 0.29mm TENSILE STRENGTH(kg/cm2) L-40.0 / W - 17.0
TEMPERATURE RANGE -32 ~ 260°C PRINTING ERROR RANGE 99.9%(Best "quality")



Official World Archery Target Face World Archery Target License #9

OUTDOOR



122cm 10-Ring
TARGET FACE **PT001F**

RANGE 90m / 70m / 60m
MARK DIMENSION 122cm x 122cm
TOTAL DIMENSION 125cm x 125cm (width / length)



80cm 10-Ring
TARGET FACE **PT002F**

RANGE 50m / 30m
MARK DIMENSION 80cm x 80cm
TOTAL DIMENSION 83cm x 83cm (width / length)

IN/OUTDOOR

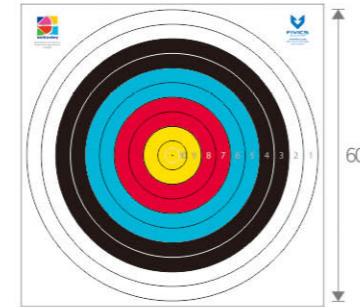

60cm 10-Ring
TARGET FACE **PT003F**

RANGE 25m
MARK DIMENSION 60cm x 60cm
TOTAL DIMENSION 63cm x 63cm (width / length)

IN/OUTDOOR

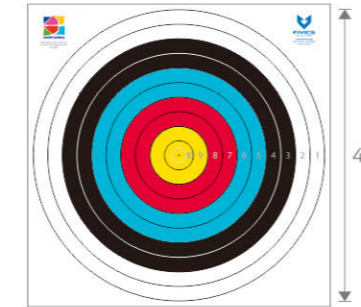

40cm 10-Ring
TARGET FACE **PT004F**

RANGE 18m
MARK DIMENSION 40cm x 40cm
TOTAL DIMENSION 43cm x 43cm (width / length)



48cm 6-Ring
TARGET FACE **PT007A**

RANGE 50m
MARK DIMENSION 48cm x 48cm
TOTAL DIMENSION 51cm x 51cm (width/length)



48cm 6-Ring Triple
TARGET FACE **PT007A3**

RANGE 50m
MARK DIMENSION 48cm x 3spot
TOTAL DIMENSION 99cm x 98.5cm (width/length)

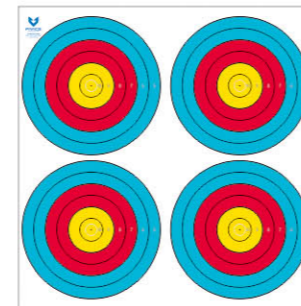

48cm 6-Ring Quadruple
TARGET FACE **PT007A4**

RANGE 50m
MARK DIMENSION 48cm x 4spot
TOTAL DIMENSION 102cm x 105cm (width / length)

INDOOR

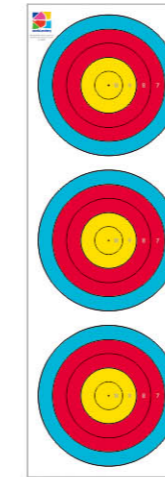

20cm Vertical Recurve
TARGET FACE
PT008F

RANGE 18m
MARK DIMENSION 20cm x 3spot
TOTAL DIMENSION 23cm x 67cm (width / length)

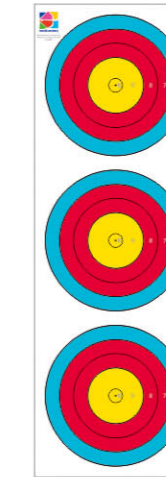

20cm Vertical Compound
TARGET FACE
PT008C

RANGE 18m
MARK DIMENSION 20cm x 3spot
TOTAL DIMENSION 23cm x 67cm (width / length)

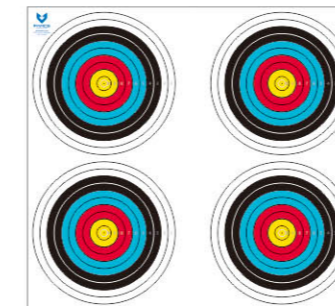

40cm 10-Ring Quadruple TARGET FACE
PT009F

RANGE 18m
MARK DIMENSION 40cm x 4spot
TOTAL DIMENSION 93cm x 85cm (width/length)

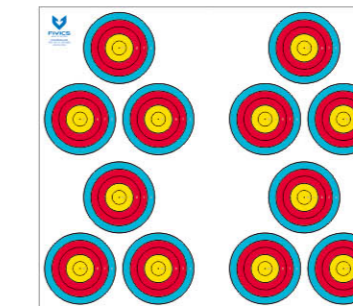

20cm Triangular 3-Spot Quadruple TARGET FACE
PT011F

RANGE 18m
MARK DIMENSION 20cm x 12spot
TOTAL DIMENSION 97cm x 85cm (width/length)

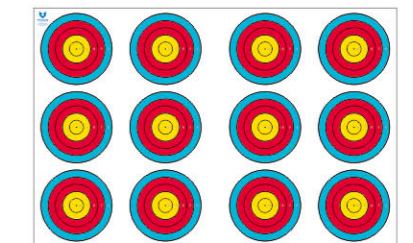

20cm Vertical 3-Spot Quadruple TARGET FACE
PT010F

RANGE 18m
MARK DIMENSION 20cm x 12spot
TOTAL DIMENSION 103cm x 67cm (width/length)

TRAINING · FIELD



Center-Spot (3ring)
TARGET FACE **PT012F**

RANGE 50m / 30m / 20m
MARK DIMENSION 24cm x 24cm
TOTAL DIMENSION 32cm x 32cm
(width / length)

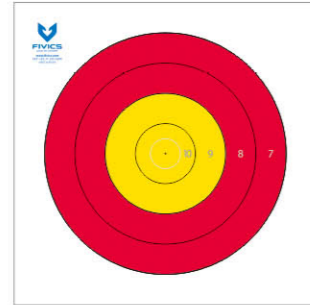

Center-Spot (4ring)
TARGET FACE **PT013F**

RANGE 90m / 70m / 60m
MARK DIMENSION 48.8cm x 48.8cm
TOTAL DIMENSION 61cm x 61cm
(width / length)

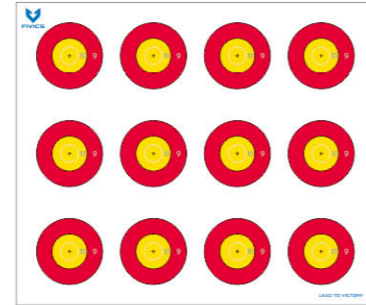

TRAINING (12spot)
TARGET FACE **PT020F**

MARK DIMENSION 52mm x 52mm
Total dimension 282mm x 238mm
(width / length)

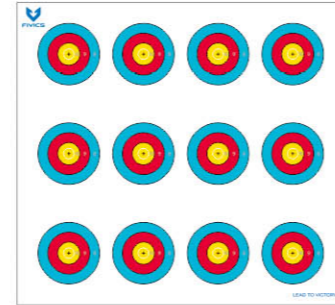

TRAINING (12spot)
TARGET FACE **PT021F**

MARK DIMENSION 48mm x 48mm
TOTAL DIMENSION 250mm x 231mm
(width / length)



FIELD 80cm
TARGET FACE **PT014F**

MARK DIMENSION 80cm x 80cm
TOTAL DIMENSION 83cm x 83cm
(width / length)



FIELD 60cm
TARGET FACE **PT015F**

MARK DIMENSION 60cm x 60cm
TOTAL DIMENSION 63cm x 63cm
(width / length)



Field 40cm Quadruple
TARGET FACE **PT016F**

MARK DIMENSION 40cm x 4spot
TOTAL DIMENSION 93cm x 85cm
(width / length)



2023
KROSSEN PRODUCT CATALOGUE



Featured in archery competitions for the Korean TV entertainment program **Idol Sports Festival**

EVERYONE CAN ENJOY ARCHERY

In April 2015, the FVICS archery center was launched with a dream to allow anyone, including non-athletic people, to enjoy archery. Now, we are making that dream a reality. The new Krossen line allows us to say "Everyone can enjoy archery with top quality and beautifully designed equipment!". In the past, beginners or intermediate archers did not much choice. But now, that has changed. We at FVICS thrive to make more options for everyone who loves archery as we do.

XENIA

ULTRA LIGHT WEIGHT RISER
FOR ENTRY LEVEL ARCHERS

XENIA RISER **HX0325**

Only 770grams / The lightest weight / Flawless coating / Showy color from painting / Perfect centroidal balance

PROCESSING Die Casting **WEIGHT** 770g **MATERIAL** Alloy Magnesium
TYPE RH / LH **GRIP** Plastic **COLOR** Painted **LENGTH** 25"



Red Blue Black White Fluorescent Green

XENIA WOOD LIMBS **LXW03G**

XENIA FOAM LIMBS **LXW03F**

Modern design / New designed tip part

MATERIAL Fiber Glass **CORE** Wood, Foam **BOW LENGTH** 66", 68", 70"
DRAW WEIGHT (lbs.) 12#~28# (2# increments)

FIVCS limbs follow the international limb fitting system (ILF) and are guaranteed to fit in all FIVCS risers and other ILF risers.

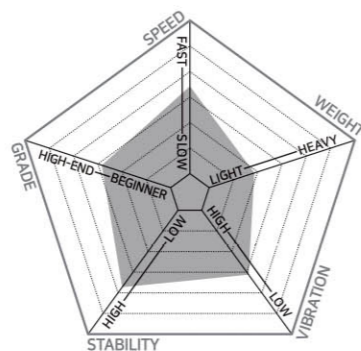

LENGTH
25

Stabilizer Mount Thread 5/16"-24 Upstabilizer Mount Thread 5/16"-24
Cushion Plunger Mount Thread 5/16"-24 Clicker Mount Thread 6/32"



XENIA LONG STABILIZER **STL02L**

XENIA SIDE STABILIZER **STL02S**

XENIA EXTENDER **STL02E**

XENIA STABILIZER effectively stacks General Modulus Carbon and Fiber Glass to provide the best elasticity and spine level for the beginner archer.

The Xenia Stabilizer excels for beginners since it diminishes vibrations using high quality materials and IIR rubber.

Refined design / Weight & damper included

MATERIAL Carbon Composite **DIAMETE** 17mm **WEIGHT** 144g(30"), 84g(12")
LENGTH Long : 26", 28", 30" / Side : 10", 12" / Extender : 3", 4"(Aluminum)

XENIA V-BAR **VBXE01**

ANGLE 40°



XENIA DAMPER **XEDA01**

THREAD 1/4"-20



WT WEIGHT

DIAMETER 20mm
WEIGHT Head-40g / Flat-26g
THREAD 1/4"-20



WTHSV

WTFVS



KROSSEN

SCORPION SIGHT SG03XE

Simple design with all the functionality required for a beginner archer

SIZE Extention 7" TYPE RH
MATERIAL Aluminum
WEIGHT 220g



SCORPION SIGHT BLOCK SG03XESB

XENIA SIGHT SG02XE

One model suitable for lefthanded and righthanded archers / RH and LH both

SIZE Extention 4"
MATERIAL Aluminum
WEIGHT 180g



XENIA SIGHT BLOCK SG02XESB

XENIA 2 CUSHION PLUNGER XENCP02

Stable performance with upgraded internal components.

MATERIAL Aluminum THREAD 5/16"-24 SIZE 61.5mm



KP REST KP001

Simple design with strong material

MATERIAL Plastick SIZE 30 x 20mm TYPE RH / LH



XENIA CLICKER XECL001

MATERIAL Stainless Steel
SIZE 100mm
THICKNESS 0.3 / 0.4mm



BOW STRING BUCKLE BS001

Suitable for many bow strings. The inner layer is composed of antiskid nylon to reduce wear on the bow string - 1set is including 2pcs



XENIA JM1 FINGER TAB **JMF01A**

SIZE L / M / S (RH)
LEATHER Cowhide



XENIA JM2 FINGER TAB **JMF02A**

SIZE L / M / S (RH)
LEATHER Cowhide



CLOVER FINGER TAB **LFTC02**

SIZE L / M / S (RH)
LEATHER Cowhide



FINGER PROTECTOR **FR001**

The size can be adjusted to any finger thickness

MATERIAL Rubber



XENIA BOW STAND **STXE01BK**

Stability
Perfect balance
Magnetic System

HEIGHT 44cm
MATERIAL Aluminum



FABRIC ARMGUARD (M) **AMF1M**



FABRIC ARMGUARD (L) **AMF1L**



HK HOLDER **AC19HKSV**



XENIA CHEST GUARD **CG06XE**

Easy fit adjustment

SIZE L, M, S TYPE RH / LH



Red Yellow Blue Pink



White



HYPER SERIES

HYPER BACK QUIVER XEQV02

420D & 600D combination of high quality material and fabric

WEIGHT 380g



Blue Yellow Red Black



HYPER TOURNAMENT QUIVER XEQV01

420D & 600D combination of high quality material and fabric

WEIGHT 460g



Blue Yellow Red Black



HYPER RECURVE BACKPACK XEB01BB

Affordable recurve backpack with a modern sophisticated design

SIZE 13.4 x 29.5 x 5.9" WEIGHT 920g

Increased stability from external shock with the application of thicker foam material.



Blue Red Black



RISER & LIMBS CASE / ARROW TUBE



KROSSEN

SPECIFICATIONS RISER

PRODUCT	LENGTH	WEIGHT	MATERIAL	PROCESSING	COLOR (Anodized)
SKADI-TX (p.16)	25"	1,314g	AL6061, Tungsten	Full CNC	Blue, Sky, Red, Black / (Painted) White, Sand, Viva Magenta
ARGON-X (p.20)	25"	1,330g	Aluminum(6061)	Full CNC	Blue, Sky, Green, Orange, Red, Purple, Black, Silver
	27"	1,380g			
TITAN-NX (p.22)	25"	1,282g	Aluminum(6061)	Full CNC	Blue, Sky, Orange, Red, Black, Silver



SKADI-TX



ARGON-X



TITAN-NX

PRODUCT	LENGTH	WEIGHT	MATERIAL	PROCESSING	COLOR (Anodized)
VELLATOR-V3 (p.24)	23"	1,100g	Aluminum(6061)	Full CNC	Blue, Green, Orange, Red, Black, Silver
	25"	1,210g			
VELLATOR-V2 (p.26)	23"	1,070g	Aluminum(6061)	Full CNC	Blue, Green, Orange, Red, Black, Silver
	25"	1,100g			
SIRASONI (p.27)	17"	1,030g	Aluminum(6061)	Full CNC	Brown, Green, Khaki, Black
XENIA (p.78)	25"	770g	Alloy Magnesium	Die Casting	Red, Blue, Black, White, Fluorescent Green / Painted



VELLATOR-V3



VELLATOR-V2



SIRASONI



XENIA

SPECIFICATIONS LIMBS

PRODUCT	CORE	MATERIAL	DRAW WEIGHT (lbs.)	LENGTH
SKADI (p.18)	WOOD	Super Graphite	32#~50#	66", 68", 70"
	FOAM			
ARGON-X (p.21)	WOOD	CWP3024 1K Full Carbon	32#~50#	66", 68", 70"
	FOAM			
TITAN-NX (p.23)	WOOD	CWP240 3K Full Carbon	32#~50#	66", 68", 70"
	FOAM			



SKADI



ARGON-X



TITAN-NX

23" RISER - LONG LIMBS 22.5~23cm | MEDIUM LIMBS 22~22.5cm | SHORT LIMBS 21.5~22cm
 25" RISER - LONG LIMBS 23~23.5cm | MEDIUM LIMBS 22.5~23cm | SHORT LIMBS 22~22.5cm
 27" RISER - LONG LIMBS 23.5~24cm | MEDIUM LIMBS 23~23.5cm | SHORT LIMBS 22.5~23cm

TILLER HEIGHT : The distance from the base of the top limb to the string should be set 2-4mm greater than the bottom.

PRODUCT	CORE	MATERIAL	DRAW WEIGHT (lbs.)	LENGTH
VELLATOR (p.25)	WOOD	CUP240 UD Carbon	22#~38#	66", 68", 70"
	FOAM			
SIRASONI (p.27)	WOOD	CWP240 3K Full Carbon	30#~55#	60", 62"
XENIA (p.78)	WOOD	Fiber Glass	12#~28#	66", 68", 70"
	FOAM			



VELLATOR



SIRASONI



XENIA



MAURO NESPOLI

Italy

- LMEDELLIN 2022 HYUNDAI ARCHERY WORLD CUP STAGE 4 | Silver
- ORAN 2022 MEDITERRANEAN GAMES | Bronze | Silver (Mixed Team)
- MUNICH 2022 EUROPEAN CHAMPIONSHIPS | Bronze (Mixed Team) | Gold (Team)
- GWANGJU 2022 HYUNDAI ARCHERY WORLD CUP STAGE 2 | Silver (Team)
- ANTALYA 2022 HYUNDAI ARCHERY WORLD CUP STAGE 1 | Silver (Team)
- LAKSO 2022 EUROPEAN INDOOR CHAMPIONSHIPS | Gold (Mixed Team) | Silver (Team)
- TOKYO 2020 OLYMPIC GAMES | Silver**
- LAUSANNE 2021 HYUNDAI ARCHERY WORLD CUP STAGE 2 | Bronze (Team)
- MOSCOW 2019 HYUNDAI ARCHERY WORLD CUP FINAL | Silver
- BERLIN 2019 HYUNDAI ARCHERY WORLD CUP STAGE 4 | Bronze | Bronze (Mixed Team)
- MINSK 2019 EUROPEAN GAMES + OG QT WORLD RANKING EVENT | Gold | Gold (Mixed Team) | Bronze (Team)
- ANTALYA 2019 HYUNDAI ARCHERY WORLD CUP STAGE 3 | Silver (Team)
- LEGNICA 2018 EUROPEAN ARCHERY CHAMPIONSHIPS | Gold (Mixed Team) | Silver (Team)
- SALT LAKE CITY 2018 HYUNDAI ARCHERY WORLD CUP | Gold
- MEXICO CITY 2017 HYUNDAI WORLD ARCHERY CHAMPIONSHIPS | Gold (Team)
- ROME 2017 HYUNDAI ARCHERY WORLD CUP FINAL | Silver (Mixed Team)
- ANTALYA 2017 HYUNDAI ARCHERY WORLD CUP STAGE 2 | Gold (Team)
- LONDON 2012 OLYMPIC GAMES | Gold (Team)**

LUIS ALVAREZ

Mexico

- PUERTO RICO CUP 2022 - CENTRAL AMERICAN AND CARIBBEAN GAMES QUALIFIER | Gold (Mixed Team)
- TOKYO 2020 OLYMPIC GAMES | Bronze (Mixed Team)**
- AMERICAN CONTINENTAL QUALIFICATION TOURNAMENT FOR TOKYO 2020 OLYMPIC GAMES | Bronze
- PARIS 2021 HYUNDAI ARCHERY WORLD CUP STAGE 3 | Bronze (Team)
- LAUSANNE 2021 HYUNDAI ARCHERY WORLD CUP STAGE 2 | Bronze (Team)
- MONTERREY 2021 PAN AND PARA PAN AMERICAN CHAMPIONSHIPS | Bronze (Mixed Team)
- GRAND PRIX MEXICANO 2019 WORLD RANKING EVENT | Bronze | Gold (Team)
- BARRANQUILLA 2018 CENTRAL AMERICAN AND CARIBBEAN GAMES WORLD RANKING EVENT | Gold | Silver (Team)
- GUATEMALA CITY WRE 2017 | Silver | Gold (Team)
- BANGKOK 2015 INDOOR ARCHERY WORLD CUP STAGE 2 | Bronze
- TORONTO 2015 PAN AMERICAN GAMES | Gold | Gold (Team)
- WROCLAW 2014 ARCHERY WORLD CUP STAGE 4 | Gold (Team)
- MEXICO CITY 2015 ARCHERY WORLD CUP FINAL | Silver (Mixed Team)
- 10TH WORLD UNIVERSITY ARCHERY CHAMPIONSHIP | Gold | Silver (Mixed Team)
- MEDELLIN 2013 ARCHERY WORLD CUP STAGE 3 | Gold (Team)
- MEXICAN GRAND PRIX 2013 | Gold | Gold (Team)



ARGON-X RISER



ARGON-X LIMBS



FORNIX-14 STABILIZER



SM540 CUSHION PLUNGER
TNS100AL UPSTABILIZER



ARGON-X RISER



TITAN-EX LIMBS

NICHOLAS D'AMOUR

Virgin Islands, US

- 2022 U.S. OPEN | Gold
- TOKYO 2020 OLIMPIC GAMES**
- ANTALYA 2021 EUROPEAN GRAND PRIX | Silver
- MVIII COPA MERENGUE | Gold | Bronze (Team)
- 2022 KAHRAMAN BAGATIR SPRING ARROWS ARCHERY TOURNAMENT | Silver
- 2022 THE VEGAS SHOOT | Silver

ALESSANDRO PAOLI

Italy

- MUNICH 2022 EUROPEAN CHAMPIONSHIPS | Gold (Team)
- GWANGJU 2022 HYUNDAI ARCHERY WORLD CUP STAGE 2 | Silver (Team)

- ANTALYA 2022 HYUNDAI ARCHERY WORLD CUP STAGE 1 | Silver (Team)
- LAKSO 2022 EUROPEAN INDOOR CHAMPIONSHIPS | Bronze (Team)
- LAUSANNE 2021 HYUNDAI ARCHERY WORLD CUP STAGE 2 | Bronze (Team)
- POREC 2021 EUROPEAN GRAND PRIX | Silver
- 2020 INTERNATIONAL ANTALYA CHALLENGE | Bronze



ARGON-X RISER



ARGON-X LIMBS



WIND CHEST GUARD



ARGON-X RISER



TITAN-EX LIMBS



FORNIX-14 STABILIZER



TENFIX FINGER TAB

THOMAS CHIRAULT

France

GT OPEN | Bronze

LAKSO 2022 EUROPEAN INDOOR CHAMPIONSHIPS | Gold (Team)

TOKYO 2020 OLYMPIC GAMES

PARIS 2021 HYUNDAI ARCHERY WORLD CUP STAGE 3 | Bronze (Team)

FINAL QUALIFIER FOR THE TOKYO 2020 OLYMPIC GAMES | Bronze (Team)

MINSK 2019 EUROPEAN GAMES +

OG QT WORLD RANKING EVENT | Gold (Team)

LEGNICA 2018 EUROPEAN ARCHERY CHAMPIONSHIPS

| Silver (Mixed Team)

SALT LAKE CITY 2018 HYUNDAI ARCHERY WORLD CUP | Bronze

BANGKOK 2018 ASIA CUP STAGE 1

| Silver | Gold (Mixed Team) | Bronze (Team)

MEXICO CITY 2017 HYUNDAI WORLD ARCHERY

CHAMPIONSHIPS | Silver (Team)

BERLIN 2017 HYUNDAI ARCHERY

WORLD CUP STAGE 4

| Gold (Team)



HAYAKAWA REN

Japan

TOKYO 2020 OLYMPIC GAMES

GWANGJU 2021 ASIA CUP LEG 1 | Silver (Mixed Team) | Silver (Team)

FIRST ASIAN GRAND PRIX 2013 | Gold (Team)

LONDON 2012 OLYMPIC GAMES | Bronze (Team)

1ST ASIAN GRAND PRIX 2012 | Gold | Silver (Mixed Team) | Bronze (Team)



MARCO GALIAZZO

Italy

TRUBALL/AXCEL ROMA ARCHERY TROPHY 2019 | Gold

MEXICO CITY 2017 HYUNDAI WORLD ARCHERY CHAMPIONSHIPS | Gold (Team)

VITTEL 2017 WORLD ARCHERY EUROPE INDOOR CHAMPIONSHIPS | Gold (Team)

LONDON 2012 OLYMPIC GAMES | Gold (Team)

ATHENS 2004 OLYMPIC GAMES | Gold

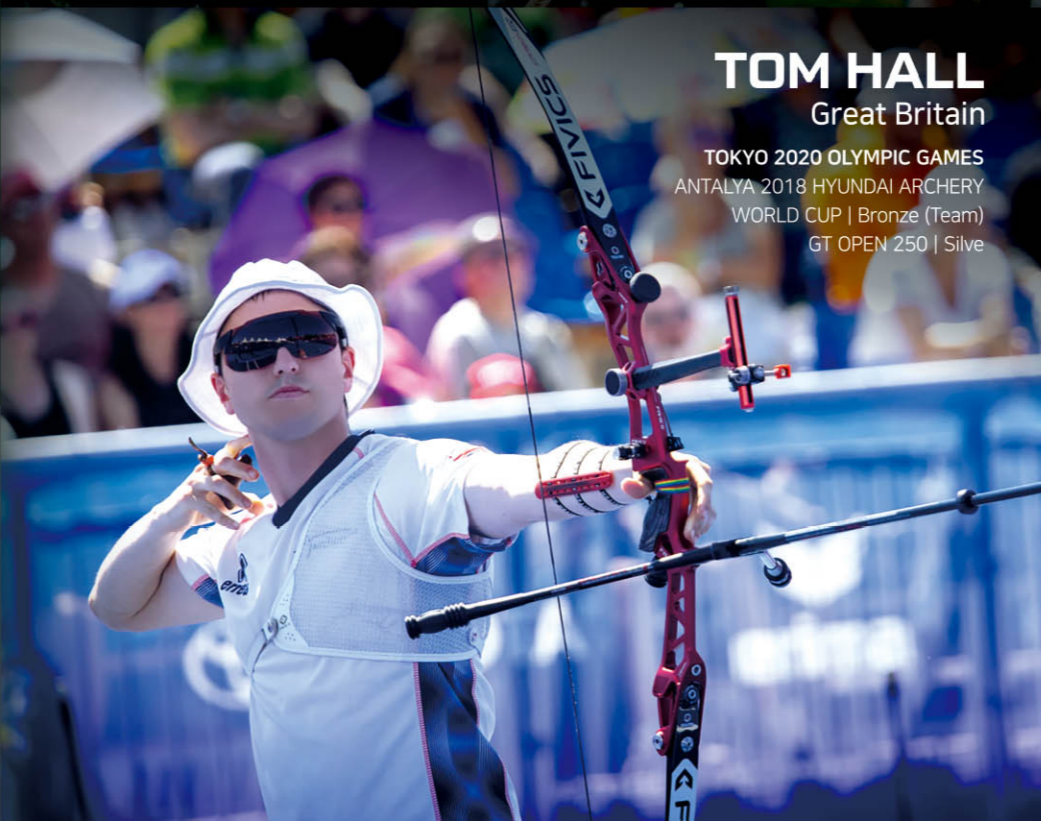

TOM HALL

Great Britain

TOKYO 2020 OLYMPIC GAMES

ANTALYA 2018 HYUNDAI ARCHERY

WORLD CUP | Bronze (Team)

GT OPEN 250 | Silver



SARAH BETTLES

Great Britain

TOKYO 2020 OLYMPIC GAMES

MINSK 2019 EUROPEAN GAMES+

OG QT WORLD RANKING EVENT

| Gold (Team)

'S-HERTOGENBOSCH 2019 HYUNDAI

WORLD ARCHERY CHAMPIONSHIPS +

OG QT WORLD RANKING EVENT

| Bronze (Team)

GT OPEN 250 | Bronze

BERLIN 2018

HYUNDAI ARCHERY

WORLD CUP

| Silver (Team)



TITAN-EX RISER



TITAN-EX LIMBS



SAKER2 FINGER TAB



WIND CHEST GUARD



Taymon Kenton-Smith Australia



Andreas Gstoettner Austria



Marina Canetta Brazil



Matheus Zwik Ely Brazil



Oscar Ticas El Salvador



Melanie Gaubil France



Jules Vautrin France



Jonathan Vetter Germany



Conor Hall Great Britain



Yulia Larkins Great Britain



David Pasqualucci Italy



Vanessa Landi Italy



Jesus Flores Mex Mexico



Sarah Fuller New Zealand



Nuno Carneiro Portugal



David Garcia Spain



Casandra Campo Tellez Spain



Cesar Vera Bringas Spain

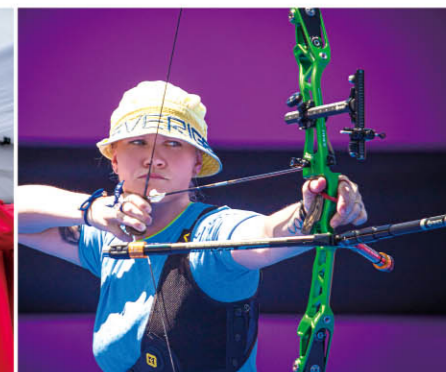

Christine Bjerendal Sweden

2023

FIVICS PRODUCT CATALOGUE

FIVICS

LEAD TO VICTORY

www.fivics.com



Follow us on Instagram!

<https://www.instagram.com/fivickorea>



Like us on Facebook!

<https://www.facebook.com/fivicsarcherykorea>



Subscribe to us on YouTube!

<https://www.youtube.com/user/fivickorea>

FIVICS KOREA (HEAD OFFICE)

Address | 42, Gwonseon-ro 668beon-gil, Gwonseon-gu, Suwon-si, Gyeonggi-do, Korea, 16566

Tel | +82-31-245-6388 **Fax** | +82-31-245-6386 **E-mail** | info@fivics.com

FIVICS CHINA (FACTORY)

Address | INDUSTRIAL PARK HOUGUZHEN ROAD XIAZHUANG CHENGYANG DIST QINGDAO CHINA

Tel | +86-532-8788-6455 **E-mail** | info@fivics.com

FIVICS USA (BRANCH)

Address | Paloma St. Los Angeles, United States of America **E-mail** | teamusa@fivics.com



FIVICS BOW LIMITED LIFETIME WARRANTY

FIVICS recurve handles are guaranteed against manufacturing defects in materials and workmanship to the original owner for the life of the product.

For more information visit us online at www.fivics.com

Note : At the time of production of our 2023 Product Guide, the bows, limbs, color options, and all other accessories shown, and the information contained, had been thoroughly checked for accuracy. However, in the event an error was made, FIVICS reserves the right to notify our dealers and customers at its discretion. Additionally, FIVICS reserves the rights to modify, change or discontinue products shown in this publication without notice.

