



Address » 42, Gwonseon-ro 668beon-gil, Gwonseon-gu, Suwon-si, Gyeonggi-do, Korea
Tel » +82-31-245-6388 Fax » +82-31-245-6386 E-mail » info@fivics.com

 Follow us on Twitter!
<https://twitter.com/FIVICSARCHERY>

 Like us on Facebook!
<https://www.facebook.com/fivics.korea>

 Subscribe to us on YouTube!
<https://www.youtube.com/user/fivicskorea>

Note: At the time of production of our 2018 Product Guide, the bows, limbs, color options, and all other accessories shown, and the information contained, had been thoroughly checked for accuracy. However, in the event an error was made, Fivics reserves the right to notify our dealers and customers at its discretion. Additionally, Fivics reserves the rights to modify, change or discontinue products shown in this publication without notice. Before using bows and other archery equipment, read all safety guidelines and warnings in the owner's manual or Online at www.fivics.com.

FIVICS BOW LIMITED LIFETIME WARRANTY

Fivics recurve handles are guaranteed against manufacturing defects in materials and workmanship to the original owner for the life of the product.

For more information visit us online at
www.fivics.com

2018 PRODUCT GUIDE

DESIGN YOUR SHOOTING 2018

FIVICS PRODUCT GUIDE

FIVICS





STORY OF TEAM FIVICS IN 2017

We appreciate and thank our archers for the great year of 2016 and 2017.

In 2016, the Fivics pro staff team have performed extraordinarily in the Rio Olympics and World Championships. In 2017, Fivics shooters our team has succeeded in the World Championships in Mexico with a gold medal. Going into 2018, we look forward to seeing even better results with our improving products. From the start, our goal is to make YOU the best in the world!



The Best Shooters, The Greatest Moments and The Finest Victory!

Fivics would like to thank all Fivics shooters and supporters of our equipment. To make the best moment, Fivics continues to research, produce and shoot with you.

We are proud to present the new 2018 Fivics equipment line to you!





FIVICS BOWS

- 10 TITAN EX RISER
- 12 TITAN X2 RISER
- 13 VELLATOR RISER
- 16 TITAN EX LIMBS
- 18 TITAN X2 LIMBS
- 20 VELLATOR LIMBS
- 22 FIVICS BOWS SPECIFICATIONS

FIVICS ACCESSORIES

- 24 FV-300 SIGHT
- 26 PHEONIX 1500D STABILIZER
- 28 PHEONIX 1500D STABILIZER
- 29 VELLATOR STABILIZER
- 30 V-BAR, DAMPER, WEIGHT
- 31 UPSTABILIZER, CUSHION PLUNGER, REST
- 32 FINGER TAB
- 35 T-GAUGE, BOW STAND, ARROW PULL, PIN NOCK

FIVICS GEAR

- 38 BOW CASE
- 42 QUIVER
- 44 PROTECTION, SOUVENIRS
- 46 TARGET FACES

KROSSEN

- 52 XENIA BOW
- 54 SIGHT, STABILIZER
- 56 ACCESSORIES
- 58 BOW CASE, QUIVER
- 60 ARROW



**TOP
SHOOTER'S
CHOICE**

FIVICS BOWS

TITAN EX
TITAN X2
VELLATOR



NEW TECHNOLOGY OF TITAN EX RISER

FIVICS ARCHERY
TITANEX

TSG TIGHT AND SECURE GRIP | 3 important points in grip system

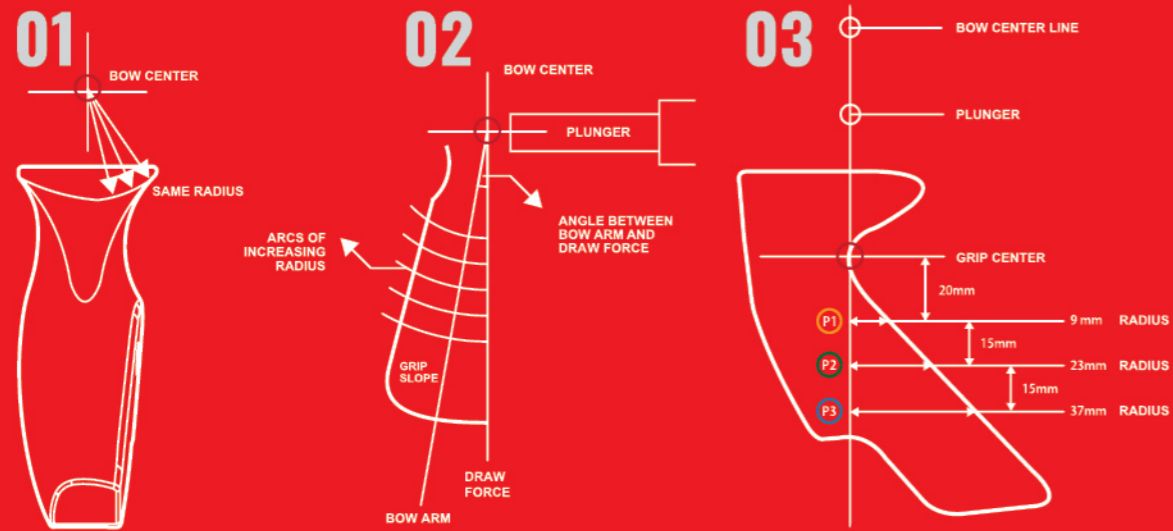

STABLE & STEADY GEOMETRY

The Titan EX's design purpose is to maximize the speed of the arrow. With the perfect centroidal balance design and the TSG (tight and secure grip), we have achieved great stability and arrows can be controlled better at high speeds

7075 RISER VS EX 6061 RISER

The Titan EX riser is designed with aluminum 6061 to allow the best vibration absorption possible. Using hydraulic press machine, we have scientifically proven that our 6061 riser can tolerate higher pressure than risers made from the more rigid materials like the 7075 aluminum

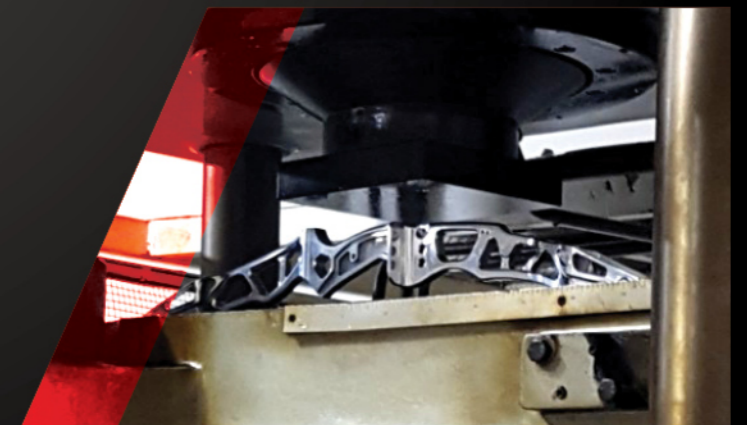
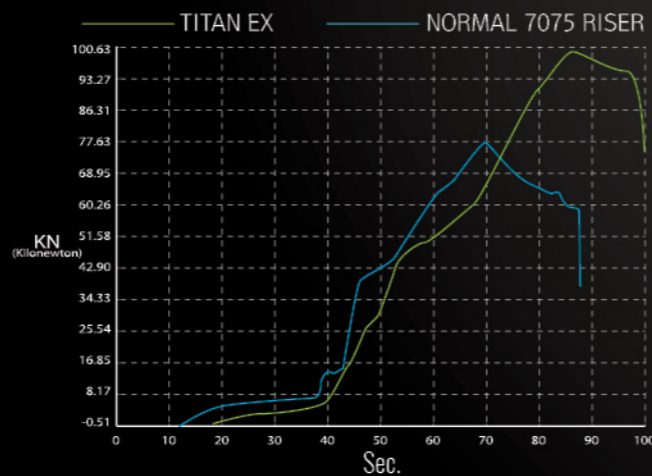

TITAN EX

Unlimited improvement

Fivics is the only archery company you can trust to endlessly challenge themselves. They have a fiery passion to make you say "Fivics will always makes new revolutionary ideas"

Precision made



HX0525 » TITAN EX RISER

- Superfine CNC milling
- Special unique designed wooden grip
- Meticulous and Precise production
- Perfect centroidal balance
- Flawless coating
- Deep color from anodizing
- Aesthetically brilliant painting

PROCESSING » **CNC**
 WEIGHT » **1,330g(25")**
 MATERIAL » **AL 6061**
 TYPE » **RH/LH**
 GRIP » **TSG Wood Grip**
 COLOR » **Anodized**

Stabilizer Mount Thread **5/16" - 24**
 Upstabilizer Mount Thread **5/16" - 24**
 Cushion Plunger Mount Thread **5/16" - 24**
 Clicker Mount Thread **6/32"**



TITAN X2

HT0525 » TITAN X2 25" RISER
HT0527 » TITAN X2 27" RISER

- Superfine CNC milling
- Special unique designed wooden grip
- Meticulous and Precise production
- Perfect centroidal balance
- Flawless coating
- Deep color from anodizing
- Aesthetically brilliant painting

PROCESSING » **CNC**
 WEIGHT » **1,315g(25")**
 MATERIAL » **AL 6061**
 TYPE » **RH/LH**
 GRIP » **High layered Wood**
 COLOR » **Anodizing**

UP
GRADE



LENGTH
27/25



Anodizing

Painting

Black Red Orange Yellow Blue Purple White



Stabilizer Mount Thread **5/16" - 24**
 Upstabilizer Mount Thread **5/16" - 24**
 Cushion Plunger Mount Thread **5/16" - 24**
 Clicker Mount Thread **6/32"**



Anodizing

Black Red Yellow Blue Pink Silver Brown

VELLATOR

HV0225 » VELLATOR 25" RISER
HV0223 » VELLATOR 23" RISER

- The lightest weight
- Only 1,100grams
- Flawless coating
- Showy color from painting
- Perfect centroidal balance

PROCESSING » **Forged & CNC**
 WEIGHT » **1,100g(25")/1,070(23")**
 MATERIAL » **AL 6061**
 TYPE » **RH/LH**
 GRIP » **Plastic**
 COLOR » **Anodizing**
 LENGTHS » **23",25"**

Stabilizer Mount Thread **5/16" - 24**
 Upstabilizer Mount Thread **5/16" - 24**
 Cushion Plunger Mount Thread **5/16" - 24**
 Clicker Mount Thread **6/32"**



LENGTH
25/23

TECHNOLOGY OF TITAN EX LIMBS

Stability / Accuracy / higher durability



SKY FLEX CWP CARBON PREPREG MATERIAL

With the cooperation of Fivics Archery and SK Chemical, we have developed the best and unique Carbon "PrePreg material" for archery. This material allows efficient pull kinetics and quick restoration.

- ▶ The most important thing in archery, Limbs is carbon's raw material
- ▶ In the process of producing good carbon materials, prepreg technology of epoxy and carbon fiber is proportional to the tension and torsion of the limbs.

Prepreg = Pre + Impregnated Material

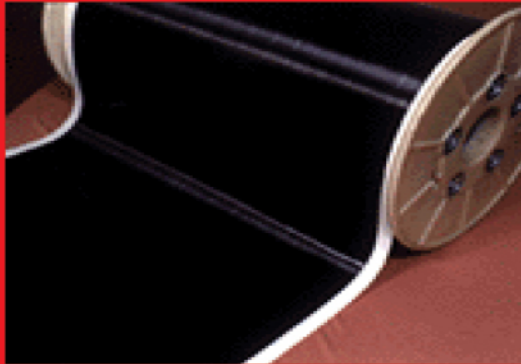

SKY FLEX = Natural Flex fiber + Epoxy Resin

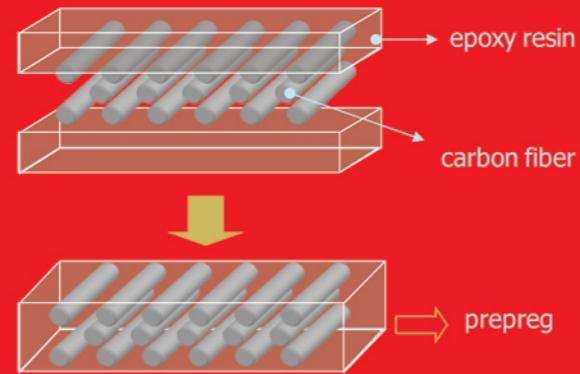

Carbon Material by SK Chemical

Increased stiffness but saved the same stability and uniform elasticity of the limb by cooperation between Fivics, and SK chemical

Plane Weave

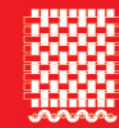

Low Drapeability
High Crimp
Good Decoration



TITAN EX LIMBS - Surprising effect of 45 degrees carbon technology

The glass fiber is used to protect the carbon but this combination reduces arrow speed due to the heavy mass weight. On the other hand, 45 degrees carbon system increases shooting stability, protecting carbon as well as reinforcing anti-twisting.

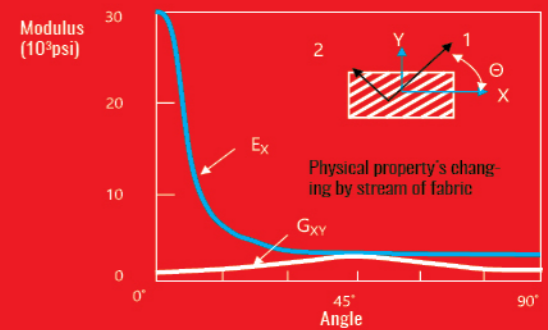

R-TECH

We utilized the CWP carbon fiber, which has a specially staggered layer structure to reduce torsion of the limb and to efficiently absorb vibration during the shot.

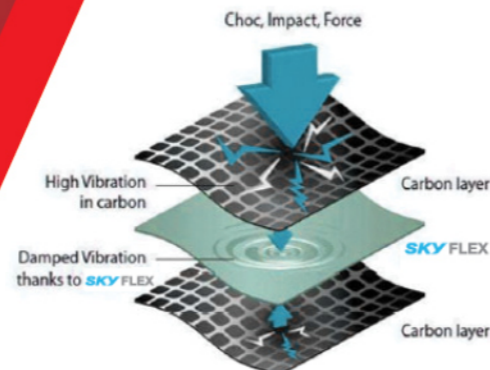

Increased stiffness but saved the same stability and uniform elasticity of the limb.

Dry fire testing for breaking and strength of limbs

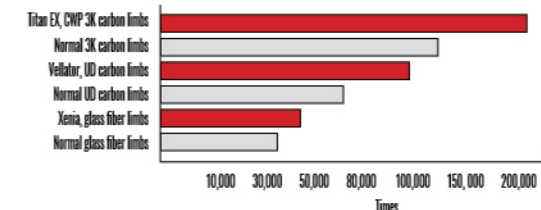

TITAN EX WOOD CORE LIMBS

LXWC01 » TITAN EX WOOD CORE LIMBS

- Clean and powerful shooting
- New Material : CWP carbon
- Light weight
- Improved limb tip design

MATERIAL » CWP 3K Full Carbon
 CORE » Wood core
 BOW LENGTH » 66",68",70"
 DRAW WEIGHT(lbs.) » 32#-50# (2# increments)

Fivics limbs follow the international limb fitting system (ILF) and are guaranteed to fit in all Fivics risers and others.

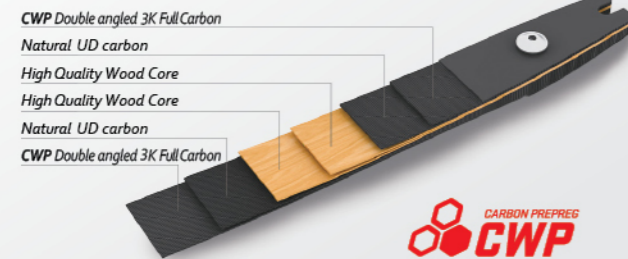

TITAN EX FOAM CORE LIMBS

LXCF01 » TITAN EX FOAM CORE LIMBS

- Clean and powerful shooting
- New Material : CWP carbon
- Light weight
- Improved limb tip design

MATERIAL » CWP 3K Full Carbon
 CORE » Foam core
 BOW LENGTH » 66",68",70"
 DRAW WEIGHT(lbs.) » 32#-50# (2# increments)

Fivics limbs follow the international limb fitting system (ILF) and are guaranteed to fit in all Fivics risers and others.

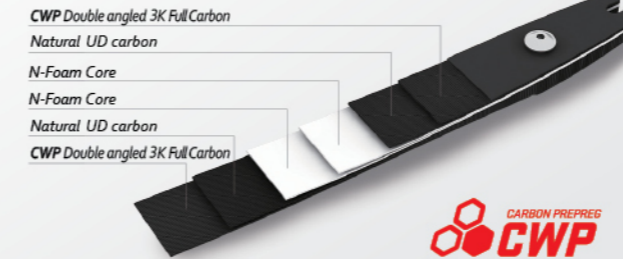

TITAN X2 WOOD CORE LIMBS

LTWC01 » TITAN X2 WOOD CORE LIMBS

- Clean and powerful shooting
- New Material : MONOCOQUE UD carbon
- Light weight
- Improved limb tip design

MATERIAL » Double angled Full Carbon
 CORE » Wood core
 BOW LENGTH » 66",68",70"
 DRAW WEIGHT(lbs.) » 32#-50# (2# increments)

Fivics limbs follow the international limb fitting system (ILF) and are guaranteed to fit in all Fivics risers and others.

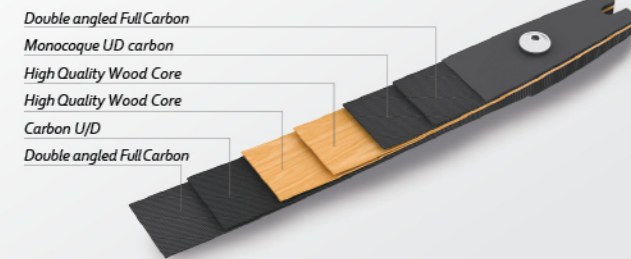

TITAN X2 FOAM CORE LIMBS

LTFC01 » TITAN X2 FOAM CORE LIMBS

- Clean and powerful shooting
- New Material : MONOCOQUE UD carbon
- Light weight
- Improved limb tip design

MATERIAL » Double angled Full Carbon
 CORE » Foam core
 BOW LENGTH » 66",68",70"
 DRAW WEIGHT(lbs.) » 32#-50# (2# increments)

Fivics limbs follow the international limb fitting system (ILF) and are guaranteed to fit in all Fivics risers and others.

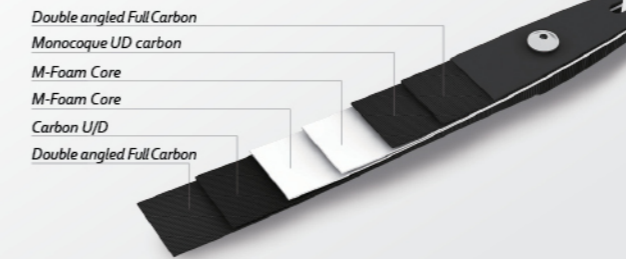



VELLATOR WOOD CORE LIMBS

LVWC02 » VELLATOR WOOD LIMBS

- Wood core only
- Makes high speed arrow
- Improved limb tip design
- Crosse carbon applied

MATERIAL » UD CARBON
CORE » Wood

BOW LENGTH » 66",68",70"

DRAW WEIGHT(lbs.) » 22#-38# (2# increments)

Fivics limbs follow the international limb fitting system (ILF) and are guaranteed to fit in all Fivics risers and others.

Fiber Glass Woven Fabric

Carbon U/D

Hard Maple Wood

Hard MapleWood

Carbon U/D

Fiber Glass Woven Fabric

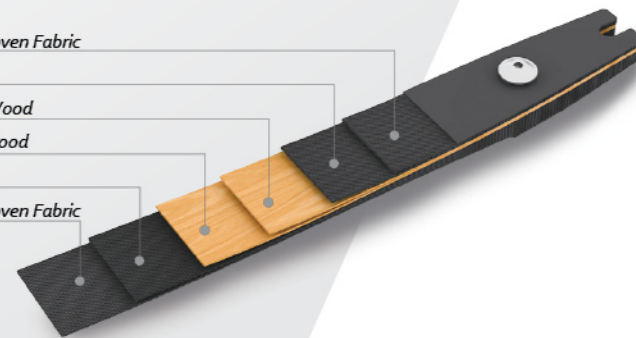

VELLATOR FOAM CORE LIMBS

LVFC02 » VELLATOR FOAM LIMBS

- Foam core only
- Makes high speed arrow
- Improved limb tip design
- Crosse carbon applied

MATERIAL » UD CARBON
CORE » Wood

BOW LENGTH » 66",68",70"

DRAW WEIGHT(lbs.) » 22#-38# (2# increments)

Fivics limbs follow the international limb fitting system (ILF) and are guaranteed to fit in all Fivics risers and others.

Fiber Glass Woven Fabric

Carbon U/D

M-Foam Core

M-Foam Core

Carbon U/D

Fiber Glass Woven Fabric

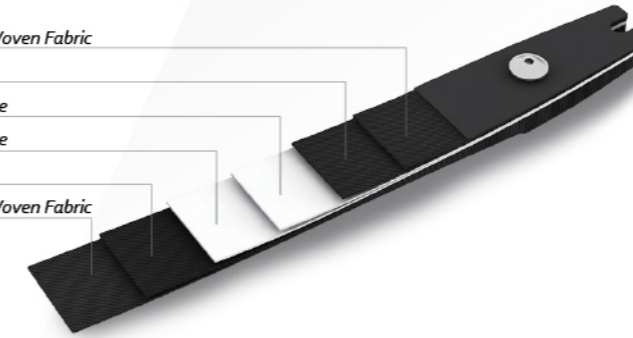

FIVICS BOWS SPECIFICATIONS

RISER TECHNICAL SPECIFICATIONS

RISER	LENGTHS	WEIGHT	MATERIAL	TYPE	COLOR (Painted)
TITIAN EX	25"	1,330g	Aluminum(6061)	RH / LH	Anodizing : Blue, Sky, Green, Yellow, Orange, Red, Purple, Black Painting : White
TITIAN X2	25" 27"	1,315g 1,330g	Aluminum(6061)	RH / LH	Anodizing : Black, Red, Orange, Yellow, Blue, Purple Painting : White
VELLATOR	23" 25"	1,060g 1,100g	Aluminum(6061)	RH / LH	Anodizing : Black, Red, Yellow, Blue, Pink, Silver, Brown
XENIA	25"	750g	Alloy Magnesium	RH / LH	Painting : Black, White, Blue, Redm Green

LIMBS TECHNICAL SPECIFICATIONS

LIMBS	MATERIAL	DRAW WEIGHT (lbs.)	LENGTHS
TITAN EX WOOD CORE	Wood / CWP 3K Full Carbon	32# - 50#	66", 68", 70"
TITAN EX FOAM CORE	Foam / CWP 3K Full Carbon	32# - 50#	66", 68", 70"
TITAN X2 WOOD CORE	Wood / Double angled Full Carbon	32# - 50#	66", 68", 70"
TITAN X2 FOAM CORE	Foam / Double angled Full Carbon	32# - 50#	66", 68", 70"
VELLATOR WOOD CORE	Wood / UD Carbon	22# - 38#	66", 68", 70"
VELLATOR FOAM CORE	Foam / UD Carbon	22# - 38#	66", 68", 70"
XENIA WOOD CORE	Wood / Fiber Glass	14#-30#	66", 68", 70"
XENIA FOAM CORE	Foam / Fiber Glass	14#-30#	66", 68", 70"

FIVICS ACCESSORIES

SIGHT
STABLIZER
CUSHION PLUNGER
REST
FINGER TAB



FV-300



8 - LOCKING SYSTEM
4 LOCKS - 8 SURFACES



FV300S » FV-300 SIGHT

- Designed for Olympic style / Recurve bows
- Specially designed weight and dampers available (included)
- VTS (Variable Tension System)
- Elevation travel tension adjustment

SIZE » Extention 9"
TYPE » RH / LH
MATERIAL » Aluminum, Carbon

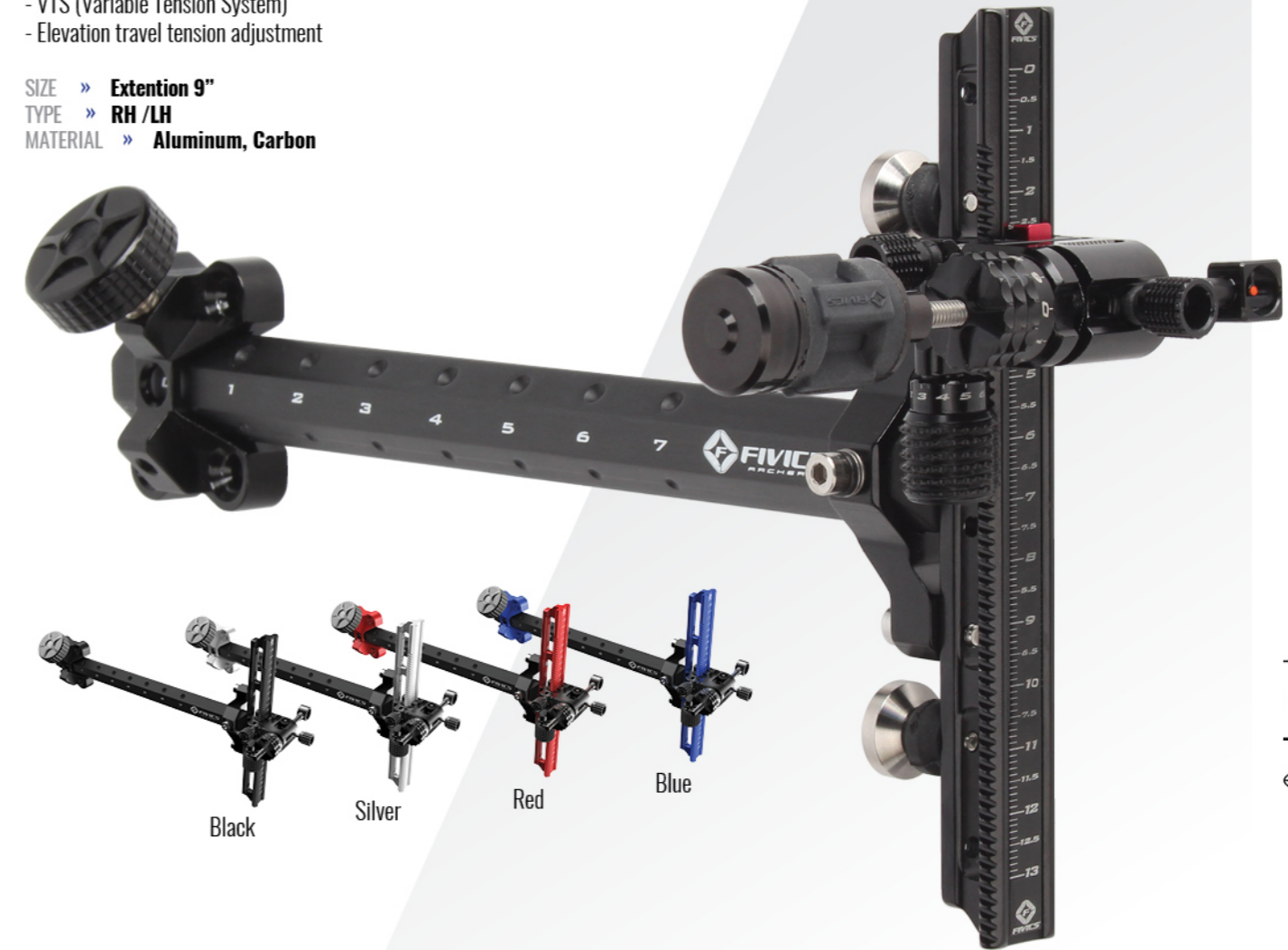

SGP01S » SIGHT PIN (SQUARE) SGP01R » SIGHT PIN (ROUND)

- Designed for Olympic style / recurve bows
- Apply all of sights

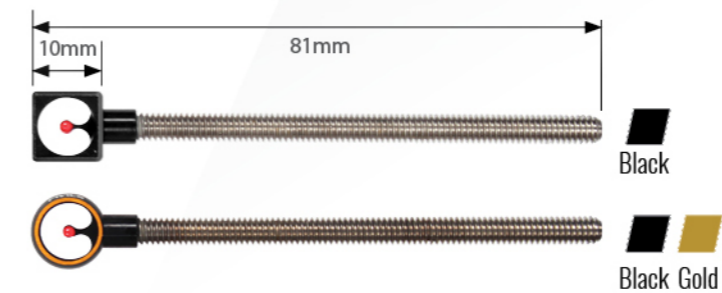

SIGHT DAMPERS

Extra special designed weight and damper are included



PHEONIX 1500D



Phoenix 1500D is made of compressed carbon to allow maximum vibration dampening during the shot while allowing wind resistance with its thin design. Fitted aluminum caps protect the high quality carbon from external shock.

- STP15CL » PHEONIX 1500D-B STABLIZER LONG(COMPOUND)
- STP15RL » PHEONIX 1500D-A STABLIZER LONG + DC1500 DAMPER (RECURVE)
- STP15RS » PHEONIX 1500D-A STABLIZER SIDE (COMPOUND, RECURVE)
- STP15RE » PHEONIX 1500D-A STABLIZER EXTENDER (RECURVE)

DIAMETER » 15.5mm
LENGTH » Long : 26", 28", 30" / Side : 8", 10", 11", 12", 13", 15" / Extender : 4", 5"
Type » A(Recurve type), B(Compound type)

Suitable weight (All weights can be used for other Fivics stabilizers. The weight listed on this page is the recommended weight to use with this stabilizer)

RECURVE TYPE

■ Carbon Shaft + Aluminum frame structure make strong attachment of cap part.



COMPOUND TYPE

■ Inner weight Extender is included(long)



■ Double dampener structures is unidirectional towards the front with no possibility of floppy end. Efficiently reduces vibration!



PX1500 WEIGHT

■ 3 kinds of weights available. Easy to use!
Weight : 26g/52g/104g



CD1500 »
PX1500 DAMPER



PHOENIX 1500D-A STABLIZER LONG(RECURVE)

PHOENIX 1500D-B STABLIZER LONG(COMPOUND)



CEX1900

- STC19L** » CEX1900 LONG STABILIZER
- STC19S** » CEX1900 SIDE STABILIZER
- STC19E** » CEX1900 EXTENDER

- 7 colors available
- Special metallic coating with vivid color
- Chrome coated cap
- Thickened extender
- Absorbing noise system
- Stabilizer screw top
- FSP system : Four Strong Pillar system
- One color extender

DIAMETER » 19mm
 EXTENDER DIAMETER » 21mm
 LENGTH » Long : 26", 28", 30" / Side : 10", 11", 12"
 / Extender : 4", 5", 6"
 WEIGHT » 130g(30"), 86g(12")

Suitable weight (All weights can be used for other Fivics stabilizers. The weight listed on this page is the recommended weight to use with this stabilizer)

UP
GRADE



Black Red Blue Yellow White

VBM01R » MAN V-BAR

Upgraded connecting bolt
 ANGLE » 40° / 45° MATERIAL » Aluminum
 COLOR » BLACK



VD200D » VD200 DAMPER

WVT 200 WEIGHT



WVT20H

WVT20F

VELLATOR

- STV01L** » VELLATOR LONG STABILIZER
- STV01S** » VELLATOR SIDE STABILIZER
- STV01E** » VELLATOR EXTENDER

- Including special laminating materials
- Damper and weight head included
- Absorbing noise system
- stabilizer + damper + weight head

DIAMETER » 18mm
 LENGTH » Long : 26", 28", 30" / Side : 9", 10", 12" / Extender : 3", 4", 5"
 WEIGHT » 130g(30"), 78g(12")

Suitable weight (All weights can be used for other Fivics stabilizers. The weight listed on this page is the recommended weight to use with this stabilizer)



VBM01R » MAN V-BAR

Upgraded connecting bolt
 ANGLE » 40° / 45° MATERIAL » Aluminum
 COLOR » BLACK



XEDA01 » XENIA DAMPER

XENIA WEIGHT



XEWH01

XEWF01



Blue Black Red



VBM01R » MAN V-BAR

Upgraded connecting bolt
 ANGLE » 40° / 45° MATERIAL » Aluminum
 COLOR » BLACK



VBTO1C » COM V-BAR

Easy to adjust, but strong holding for compound bow
 MATERIAL » Aluminum



VBC02C » COM CONNECTING BOLT

Quick disconnection
 MATERIAL » Aluminum
 ANGLE » -10°



DV1500 » DC1500 DAMPER

Thread » 1/4"-20



VD200D » VD200 DAMPER

Thread » 1/4"-20



VZEROL » V-ZERO DAMPER

Thread » 1/4"-20



VZEROM » V-ZERO MINI-DAMPER

Thread » 1/4"-20



PX1500 WEIGHT

Diameter : 29mm
 Weight : 26g/52g/104g
 Thread » 1/4"-20



VWT200 » VWT 200 WEIGHT

Diameter : 24mm
 Weight : Head-38g / Flat-38g
 Thread » 1/4"-20



CONVERTER SCREW

*Applicable for all dampers



TNS100 » TNS100AL UPSTABILIZER

Weight : 90g Thread » 5/16"-24



TNV230 » TNV 2300 UPSTABILIZER

Weight : 80g Thread » 5/16"-24



SM540W » SM540 CUSHION PLUNGER

Compact size to make easy setting

Thread : 5/16" - 24
 Adjustable Length : min 19.5mm, max 26.5mm

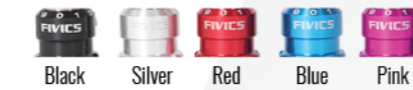

SM740W » SM740 CUSHION PLUNGER

Window checking

Thread : 5/16" - 24
 Adjustable Length : min 19.5mm, max 26.5mm



BRS001 » BUTTERFLY REST

Ambidextrous Design



MRS001 » MR REST

Stainless steel ensured durability while reducing friction.



TCS001 » TC REST

Height adjustable high-end stainless steel rest.



SAKER SERIES



SFT04A » Saker+ Plus finger tab

SIZE » L / M / S (RH is new model, but LH is old version in 2016)

Saker+ Plus finger tab is 4mm thick, allows 3 weight control systems and 5 angle adjustment system through precise machining of the aluminum plate.

Saker+ Plus finger tab can be adjusted to fit the archers shape and preference to allow more stable hooking position, making it the best tab to shoot perfectly in any competition.

And also, it is very easy to cover the special parts for the thumb and little finger.

We at Fivics understand that shooters have different preferences and we will thrive to consider all of them.

Saker + Plus finger tab's spacer is designed to bend to your preferred hand shape for more comfortable shots. It also looks like an elephant!

Fivics is using high quality cordovan leathers only which is provided by H company with one hundred years history in U.S.A

1 Angle Adjustment



2 Adjustable Ledge



3 Weight Control



4 Balance Control



- Ergonomic design
- Adjustable ledge
- Replaceable face and backing
- Optional finger spacer available



BFT01A » BRASS SAKER 1

SIZE » L / M / S (RH / LH)

WEIGHT » L 162g, M 152g, S 144g

LEATHER » Cordovan



BFT02A » BRASS SAKER 2

SIZE » L / M / S (RH / LH)

WEIGHT » L 150g, M 140g, S 136g

LEATHER » Cordovan



SFT01A » SAKER 1

SIZE » XL / L / M / S / XS / XXS (RH / LH)

LEATHER » Cordovan



COLOR



SFT02A » SAKER 2

SIZE » XL / L / M / S / XS / XXS (RH / LH)

LEATHER » Cordovan



COLOR



SFT03A » SAKER 3

SIZE » L / M / S (RH / LH)

LEATHER » Cordovan



COLOR



EP002S » SAKER 1 FINGER TAB FRAME EP

EP001 only fits Saker 1 finger tab

It offers top shooters another value for their hooking direction, comfortable and balanced.

This component enhances the saker finger tab's Ergonomic design



Size » saker1 XL , L = EP (L size)
saker1 M , S = EP (M size)
saker1 XS , XXS = EP (S size)



WA RULES Book3, Chapter 11, Article 11.18

The Technical Committee concluded that if the bar extends to the wrist but not beyond (extends at or before the contact point between the hand and the wrist), then the extension is legal.
World Archery C&R Committee, 22 September 2014



POLITE SERIES

PFT03N » POLITE 3 FINGER TAB

- Emphasizes the sense of unity in your hands.
- Absolute stability, accuracy, and sense of unity of hooking
- 5 Distribution and support of the optimal force by using the whole fingers
- Ergonomic 3D design
- Aluminium & anodizing surface treatment

SIZE » L / M / S (RH / LH)
 COLOR » Champagne Gold



PFT02N » POLITE 2 FINGER TAB

- **Adjustable ring finger rest**
- Emphasizes the sense of unity in your hands.
- Absolute stability, accuracy, and sense of unity of hooking
- 5 Distribution and support of the optimal force by using the whole fingers
- Ergonomic 3D design
- Aluminium & anodizing surface treatment

SIZE » L / M / S (RH / LH)
 COLOR » Champagne Gold



FINGER SPACER



FS004D
 Material : Rubber
 Size : 39.8 x 29.3 x 16.2mm
 Weight : 14g
 COLOR

FS004S
 Material : Rubber
 Size : 32 x 28 x 12.4mm
 Weight : 10g

FS001
 Material : Plastic
 Size : 36 x 28.3 x 12.3mm
 Weight : 8g

FS006
 Material : Plastic & Rubber
 Size : 40 x 29 x 10mm
 Weight : 10g



AC05AT » CARBON T-GAUGE BOW SQUARE

Material : Carbon

ST001S » AUTOMATIC (SHORT) ST001L » AUTOMATIC (LONG) BOW STAND

Height : 44cm [ST001S], 65cm [ST001L]
 Weight : 573g [ST001S], 680g [ST001L]
 Material : Aluminum



AC23PU » FIVICS ARROW PULL



NC001S | FIVICS Pin Nock(S) NC001L | FIVICS Pin Nock(L)

This universal pin nock fits all standard pin nock adapters. It is made from a durable polycarbonate material that performs shot after shot.

Available in two size: #1 fits 12-18 strand strings / #2 fits 20-24 strand strings

SI-X10 » X-NET PIN NOCK ADAPTER

designed for X-10 arrows

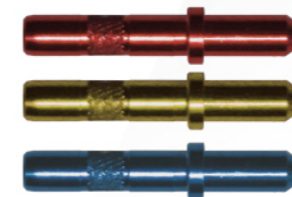

FIVICS GEARS

Secret masterpieces
World famous craftsmen researched, designed and produced

BOW CASE
QUIVER
PROTECTION
ETC



BCHD01 » AEGIS HARD CASE DOUBLE

- High quality hardcase
- This model can hold up to two recurve bows and their accessories

*Recommended maximum weight : 23kg

Size : 33" X 15" X 10"
Material : ABS+PC
Pocket : 1pcs



Pink

Blue

Red

Black

Silver

White

HARDCASE RAIN COVER



HARDCASE BELT



Rain cover / Case belt included

BCHD02 » AEGIS HARD CASE SINGLE

- Lightweight
- Strong enough against bad moving
- Special designed wheels
- Showy colors
- This model can hold up to one recurve bows and their accessories

Size : 830×320×190mm
Material : ABS+PC
Pocket : 1pcs

*Recommended maximum weight : 23kg



Black

Silver

White

HARDCASE RAIN COVER



HARDCASE BELT



Rain cover / Case belt included





BCB02TM » TENTRON-M BACKPACK

Size : 11.8" X 7.8" X 26.7"
 Pocket : 1pcs
 Weight : 2.4kg



- + Arrow tube
- + Equipment case
- + Riser & Limbs case included
- + Rain Cover

RLC01D » RISER & LIMBS CASE

Size : 27 X 7.5 X 3"
 Weight : 800g



EC04AT » FIVICS ARROW TUBE



BC2L01 » Folding case(2 level)

- Compact size
- Including riser & limbs and arrow and equipment cases

Size : 28.5 X 10.5"
 Weight : 900g



EC03TB » TOOL BOX

Size : 8.5 X 7 X 7"



STPRO1 » PRO HANDPOCKET NEW

Size : 5X2.5X6"
 Weight : 80g



UNICO SERIES



QVUNTL » UNICO QUIVER LARGE QVUNTS » UNICO QUIVER SMALL

Artificial leather provides you with elegance.

Extra "L" size belts are on sales

SIZE » Large / Small
WEIGHT » L-502g / S- 418g
TYPE » RH / LH



Orange Green Blue Pink

QVUNBN » UNICO BACK

Artificial leather provides you with elegance.

Extra "L" size belts are on sales

TYPE » RH / LH
WEIGHT » 380g



Orange Green Blue Pink



ACCENDO SERIES



QV02AT » ACCENDO TOURNAMENT

Light weight (630g)
Large pocket for accessories

TYPE » RH / LH



Black Blue Red Pink

QV02AB » ACCENDO BACK

Light weight (260g)
Large pocket for accessories

TYPE » RH / LH



Black Blue Red Pink





CG03A2 » A2

Adjust a shoulder band
The button system to adjust sides
Large : From XL to M
Medium : From L to S
Small : From M to XS
SIZE » L, M, S
TYPE » RH / LH
COLOR



Black White Blue Red Yellow Pink

AM001W » ORGANIC WEB

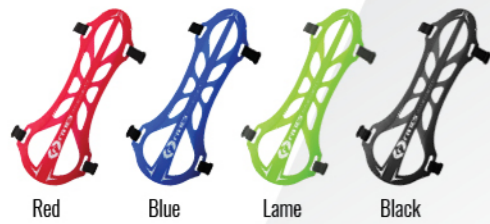

Red Blue Lime Black

AMH01J » SILICON JELLY



White Blue Green Yellow Red Pink Purple



AC20LP » Limb Protector

The device to protect the tip part and your feet when setting up bows.

Size : 56X97 mm
Material : Rubber

CLOTHES

Size : XS / S / M / L / XL / XXL



AC29JW

AC29JY

AC12CA » FIVICS LOGO MESH CAP



NEW

Blue

Red

Black

AC17SO » FIVICS LOGO SOCKS(3PAIRS=1SET)



AC26CS » COOL ARM SLEEVE



UMBLO1 » UMBRELLA

length : 1m
opened size : 1m 60cm



AC04CL » CLOCK



PERFECT TARGET FACE



WATER PROOF

FIVICS TARGET FACE FUNTION

- + Material : Polyester
- + Thickness : 0.29mm
- + Tensile strenght(kg/cm²) : (L-40.0 / W - 17.0)
- + Temperature range : -32 ~ 260°C
- + Printing error range : 99.9%(Best "quility")



OUTDOOR TARGET FACE

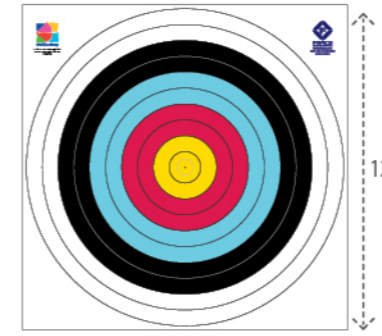

PT 001F OUTDOOR 122cm Target Face
Range : 90m / 70m / 60m
Mark dimension : 122cm X 122cm
Total dimension : 125cm X 125cm (width/length)

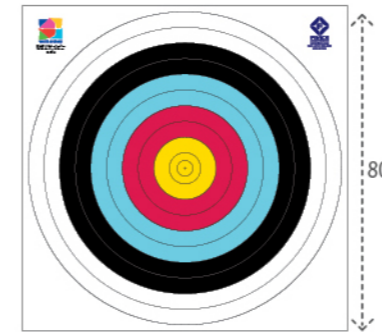

PT 002F OUTDOOR 80cm Target Face
Range : 50m / 30m
Mark dimension : 80cm X 80cm
Total dimension : 83cm X 83cm (width/length)

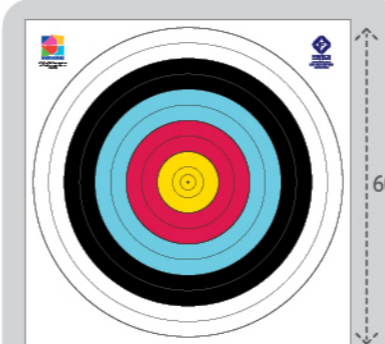

PT 003F OUTDOOR 60cm Target Face
Range : 25m
Mark dimension : 60cm X 60cm
Total dimension : 63cm X 63cm (width/length)

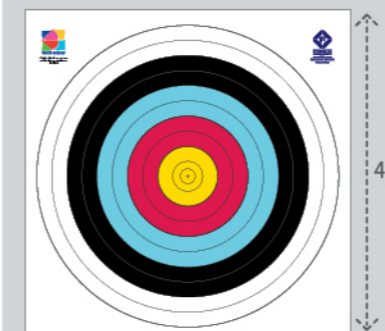

PT 004F OUTDOOR 40cm Target Face
Range : 18m
Mark dimension : 40cm X 40cm
Total dimension : 43cm X 43cm (width/length)

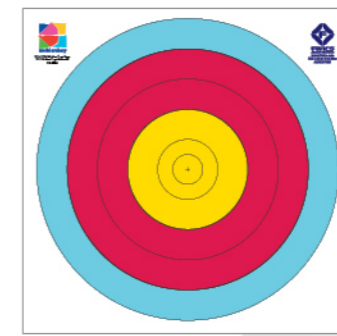

PT 005F OUTDOOR 40cm-5ring Target Face
Range : 30m / 20m
Mark dimension : 40cm X 40cm
Total dimension : 43cm X 43cm (width/length)

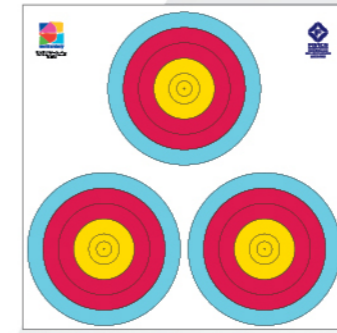

PT 006F OUTDOOR Triangular Target face(5Line)
Range : 30m / 20m
Mark dimension : (40cm-Center X 3Target)
Total dimension : 85cm X 85cm (width/length)

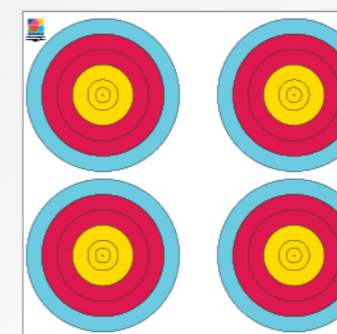

PT 007F OUTDOOR Target face(5Line)
Range : 30m / 20m
Mark dimension : (40cm-Center X 4Target)
Total dimension : 93cm X 85cm (width/length)

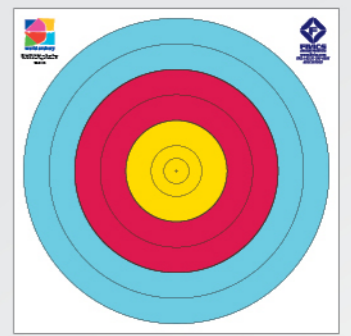

PT 007A OUTDOOR 48cm-6ring Target Face
Range : 50m
Mark dimension : 48cm X 48cm
Total dimension : 51cm X 51cm (width/length)

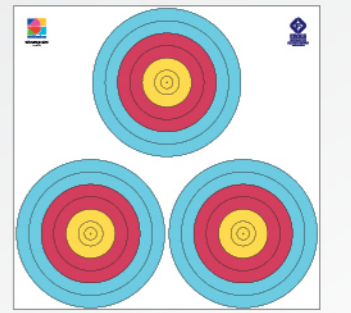

PT 007A3 OUTDOOR Triangular Target face(6Line)
Range : 50m
Mark dimension : (48cm-Center X 3Target)
Total dimension : 99cm X 98.5cm (width/length)

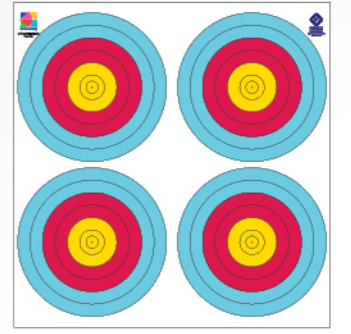

PT 007A4 OUTDOOR Triangular Target face(6Line)
Range : 50m
Mark dimension : (48cm-Center X 4Target)
Total dimension : 102cm X 105cm (width/length)

OUT/INDOOR TARGET FACE



Official World Archery Target Face
World Archery Target License #1

Waterproof

ASIA ONLY ONE WA TARGET FACE LICENSED MANUFACTURER



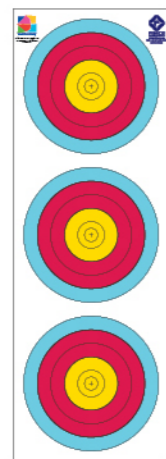

PT 008F INDOOR 20cm Target Face(18m)
Range: 18m
Mark dimension : 20cm X 3 Target
Total dimension : 23cm X 67cm (width/length)

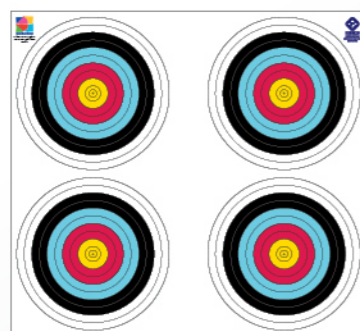

PT 009F INDOOR Single Target Face
Range: 18m
Mark dimension : 40cm X 4 Target
Total dimension : 93cm X 85cm (width/length)

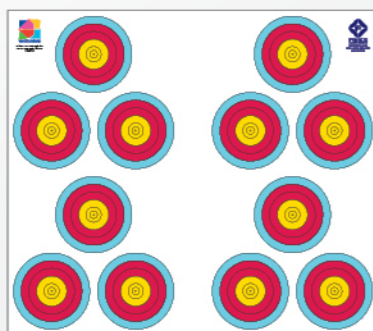

PT 011F INDOOR 20cm Triangular Triple Target Face
Range: 18m
Mark dimension : 20cm X 3 X 12 Target
Total dimension : 97cm X 85cm (width/length)

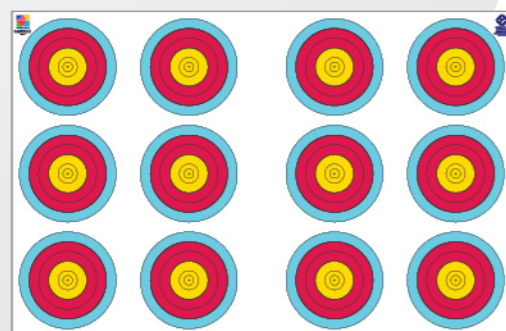

PT 010F INDOOR 12cm Target Face(18m)
Range: 18m
Mark dimension : 20cm X 12 Target
Total dimension : 103cm X 67cm (width/length)



PT 012F TRAINING 80cm-CenterSpot Target Face(8Line)
Range : 50m/30m/20m
Mark dimension : 24cmX24cm
Total dimension : 32cmX32cm(width/length)

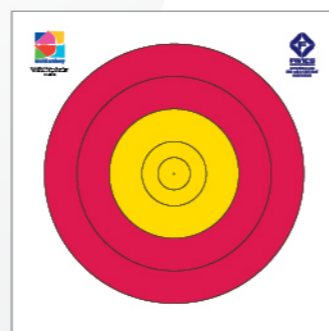

PT 013F TRAINING 122cm-CenterSpot Target Face(7Line)
Range : 90m/70m/60m
Mark dimension : 48.8cmX48.8cm
Total dimension : 61cmX61cm(width/length)

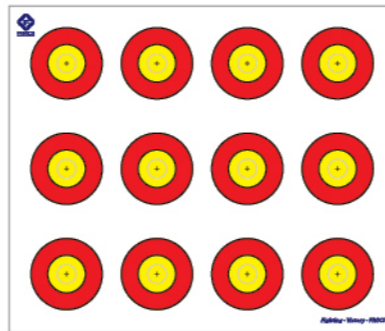

PT 020F TRAINING Target Face
Mark dimension : 52mmX52mm
Total dimension : 282mmX238mm(width/length)

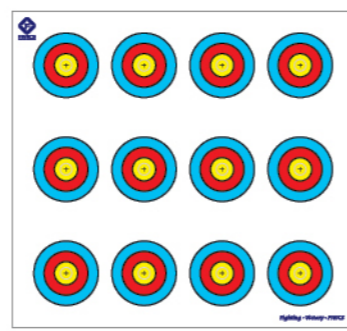

PT 021F TRAINING Target Face
Mark dimension : 48mmX48mm
Total dimension : 250mmX231mm(width/length)



PT 014F FIELD 80cm Target Face
Mark dimension : 80cmX80cm Target
Total dimension : 83cmX83cm(width/length)



PT 015F FIELD 60cm Target Face
Mark dimension : 60cmX60cm Target
Total dimension : 63cmX63cm(width/length)

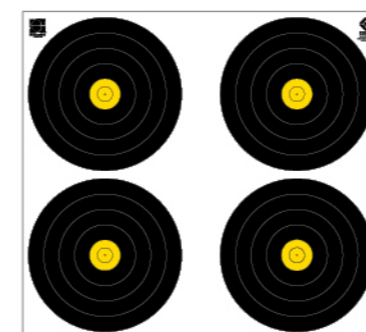

PT 016F FIELD 40cm Target Face
Mark dimension : 40cmX40cm
Total dimension : 93cmX85cm(width/length)

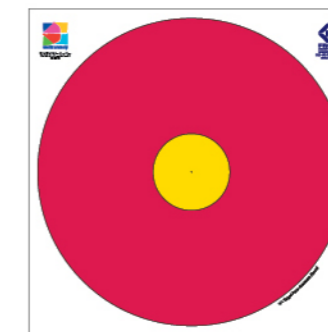

PT 017F OUTDOOR Target Face
Range : 70m
Mark dimension : 97.2cmX97.2cm
Total dimension : 103cmX103cm(width/length)

PAG002 » TARGET SCORE BOOK



ASIA FIRST WA TARGET FACE LICENSED MANUFACTURER



TOTAL PERFORMANCES ARE MADE OF PRECISION

energy 

2018

 KROSSEN

 KROSSEN
HIGH PERFORMANCE WOOD TECHNOLOGY
XENIA™
ARCHERY

“Everyone can enjoy Archery”

In April 2015, the Fivics archery center was launched with a dream to allow anyone, including non-athletic people, to enjoy archery. Now, we are making that dream a reality. The new Krossen line allows us to say “Everyone can enjoy archery with top quality and beautifully designed equipment!”. In the past, beginners or intermediate archers did not much choice. But now, that has changed. We at Fivics thrive to make more options for everyone who love archery as we do.

made by
FIVICS

XENIA RISER

HX0325 » XENIA RISER

- The lightest weight
- Only 770grams
- Flawless coating
- Showy color from painting
- Perfect centroidal balance

PROCESSING » **DIE-CASTING**
 WEIGHT » **770g**
 MATERIAL » **Alloy Magnesium**
 TYPE » **RH**
 GRIP » **Plastic**
 COLOR » **Painted**
 LENGTHS » **25"**

Painting



XENIA LIMBS

LXW03G » XENIA WOOD LIMBS LXW03F » XENIA FOAM LIMBS

- Modern design
- New designed tip part

MATERIAL » **Fiber Glass**
 CORE » **Wood, Foam**
 BOW LENGTH » **66",68",70"**
 DRAW WEIGHT(lbs.) » **14#-30# (2# increments)**

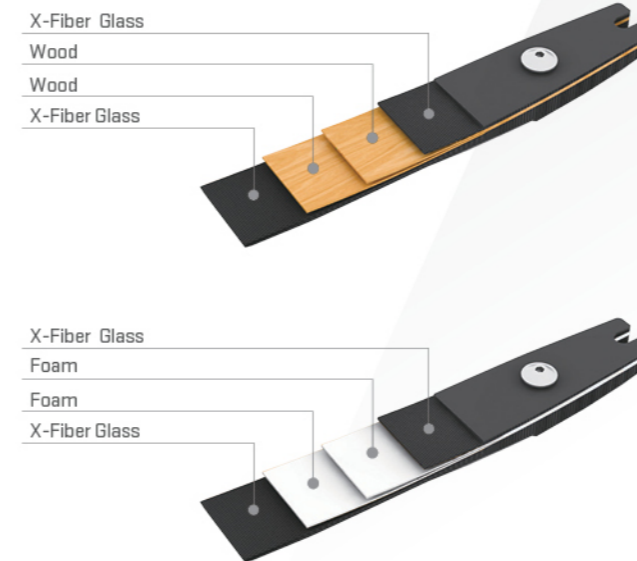

NEW



KROSSEN SIGHT



SG03XE » SCORPION SIGHT

RH and LH both

SIZE » Extention 7"
 MATERIAL » Aluminum
 WEIGHT » 220g

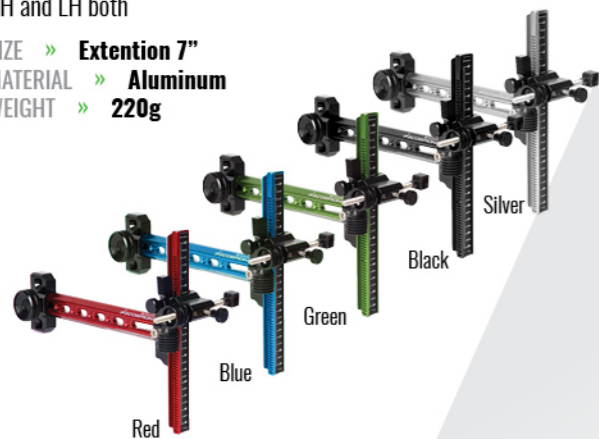

SG02XE » XENIA SIGHT

RH and LH both

SIZE » Extention 4"
 MATERIAL » Aluminum
 WEIGHT » 180g



XENIA STABILIZER

- STL01L » XENIA LONG STABILIZER
- STL01S » XENIA SIDE STABILIZER
- STL01E » XENIA EXTENDER

- Refined design
- Weight & damper included

MATERIAL » CARBON COMPOSITE
 DIAMETE » 17mm
 WEIGHT » 116g(30"), 65g(12")
 LENGTH » Long : 26", 28", 30"
 Side : 10", 12"
 Extender : 3", 4"

VBXE01 » XENIA V-BAR

Angle: 40°



XEDA01 » XENIA DAMPER



XENIA WEIGHT



* Suitable weight(All weight can be used for other stabilizers, but we recommend you to us the above in advance)



LEOC01 » XENIA LEO CUSHION PLUNGER



Black Blue Red Green

MATERIAL » Aluminum
Thread : 5/16" - 24
SIZE » 61.5mm



XECLO1 » XENIA CLICKER

MATERIAL » Stainless Steel
SIZE » 100mm



Green Black

STXE01 » XENIA STAND

- Stability
- Perfect balance
- Magnetic System

HEIGHT » 44cm
MATERIAL » Aluminum



KP001R » KP REST

MATERIAL » Plastick
SIZE » 30*20mm



LFTJ01 » XENIA JM1

SIZE » L / M / S (RH / LH)
LEATHER » Cowhide



LFTJ02 » XENIA JM2

SIZE » L / M / S (RH / LH)
LEATHER » Cowhide



LFTCN1 » NEONINE A

SIZE » L / M / S (RH / LH)
LEATHER » Cowhide



CG06XE » XENIA CHEST GUARD

SIZE » L, M, S
TYPE » RH / LH



White



Red

Blue

Yellow

Pink

FABRIC ARMGUARD



AMS01S



AMS01M



AMS01L

AMS01B SPIDERMAN ARMGUARD



HYPER BACKPACK



XEB01B » HYPER Recurve backpack

SIZE » 340*750*150mm WEIGHT » 11kg

*Increased more stability from external shocks by applying more thicker foam material



Green Blue Pink Red Gray



+ Riser & Limbs case included
+ Arrow tube



EC04AK » ARROW TUBE



HYPER QUIVER

XEQV01 » HYPER Quiver

* 420D & 600D combination of high quality material a fabric

WEIGHT » 460g



Green Red Blue Pink Gray



XEQV02 » HYPER Back Quiver

* 420D & 600D combination of high quality material a fabric

WEIGHT » 380g



Green Red Blue Pink Gray

AC19EH » HK HOLDER





MACH3

ARMC03 » MACH3 ARROW

Beginner **Carbon** Arrow

Size : 400/500/600/700/800/900/1000/1100/1300/1500/1800(11 kinds of spines)

Shaft only : one dozen/12pcs

Finished arrow : one dozen/12pcs = shaft + 1.65" vanes + In-nock + break-off point

Straightness: ± 0.004"

MACH TARGET POINTS

90-100g



Vanes

1.65"



In Nock



Shaft Size	Qty	Stock Lengh inch	Spine	Point Weight
400	12 pack	33"	500	90-100g
500	12 pack	33"	500	90-100g
600	12 pack	33"	600	90-100g
700	12 pack	33"	700	90-100g
800	12 pack	33"	800	90-100g
900	12 pack	33"	900	90-100g
1000	12 pack	30"	1000	90-100g
1100	12 pack	30"	1100	90-100g
1300	12 pack	30"	1300	90-100g
1500	12 pack	30"	1500	90-100g
1800	12 pack	30"	1800	90-100g

NINJA

ARMC01 » NINJA ARROW

Beginner **Carbon Composite** Arrow

Size : 400/500/600/700/800/900/1000/1100/1300/1500/1800(11 kinds of spines)

Shaft only : one dozen/12pcs

Finished arrow : one dozen/12pcs = shaft + 1.65" vanes + In-nock + break-off point

Straightness: ± 0.006"

MACH TARGET POINTS

90-100g



Vanes

1.65"



In Nock



Shaft Size	Qty	Stock Lengh inch	Spine	Point Weight
400	12 pack	33"	500	70-80g
500	12 pack	33"	500	70-80g
600	12 pack	33"	600	70-80g
700	12 pack	33"	700	70-80g
800	12 pack	33"	800	70-80g
900	12 pack	33"	900	70-80g
1000	12 pack	30"	1000	70-80g
1100	12 pack	30"	1100	70-80g
1300	12 pack	30"	1300	70-80g
1500	12 pack	30"	1500	70-80g
1800	12 pack	30"	1800	70-80g



TOP SHOOTER'S CHOICE



128 shooters in Rio 2016,
81 top shooter's choice



Live for the pursuit of perfection.
Be strong and bold.
Trust your shot.
Enjoy archery with Fivics and get
a taste of victory!

